

LL-B220 寸法図

Dimensional Drawings

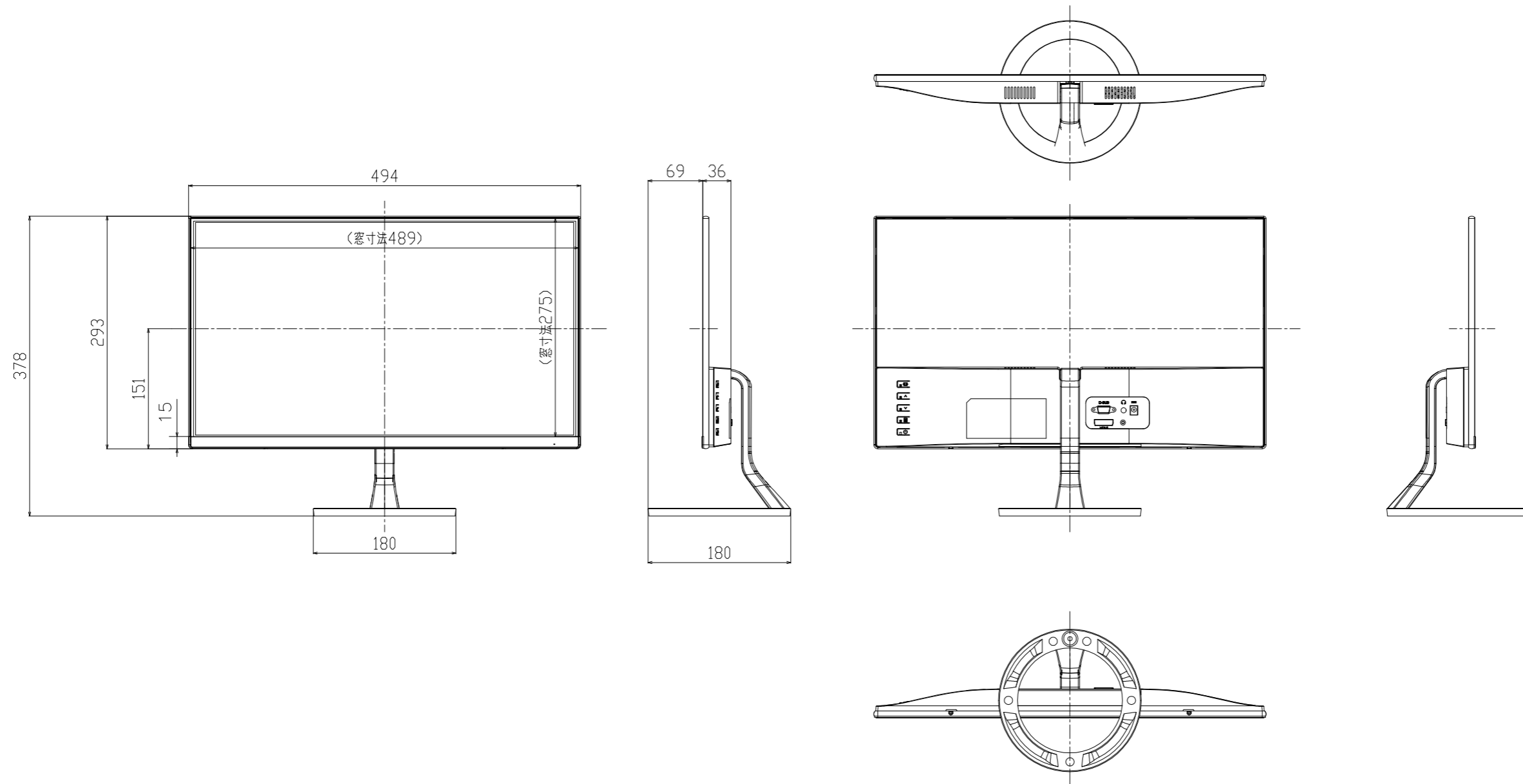

単位 : mm

Unit : mm