

**SHARP®**

**PN-L703W**

**PN-L603W**

**PN-70TW3**

**PN-60TW3**

**WIRELESS CONTROLLER  
OPERATION MANUAL**

# Contents

<b>Introduction</b> .....	<b>3</b>
System requirements for the computer to be connected .....	5
<b>Preparations</b> .....	<b>6</b>
Change the monitor to Wireless mode .....	8
Connect the computer to the wireless controller.....	8
MirrorOp for SHARP preparations .....	11
Start MirrorOp for SHARP .....	12
<b>Wireless mode screen</b> .....	<b>14</b>
<b>Displaying the computer screen</b> .....	<b>15</b>
Operation from the monitor .....	15
Displaying multiple screens at once.....	15
Operation from the connection software .....	16
Controlling the computer whose screen is displayed (Conference control mode).....	21
Displaying the image in a web browser (WebSlides).....	22
Displaying a computer screen on multiple monitors.....	23
<b>Actions when a screen is displayed</b> .....	<b>24</b>
Drawing on the screen with a pen (Direct Drawing).....	24
Saving the screen as an image file .....	25
<b>Exiting</b> .....	<b>26</b>
<b>Settings</b> .....	<b>27</b>
<b>Starting from a commercially available USB flash drive</b> .....	<b>30</b>
<b>Uninstalling the connection software</b> .....	<b>31</b>
<b>Using as a whiteboard (Direct Drawing)</b> .....	<b>32</b>
<b>Intellectual Property Rights and Other Matters</b> .....	<b>34</b>

## Important Information

- This product has been shipped after strict quality control and product inspection. If, however, you find any failure or malfunction, contact your product dealer.
- Please understand that SHARP CORPORATION bears no responsibility for errors made during use by the customer or a third party, nor for any other malfunctions or damage to this product arising during use, except where indemnity liability is recognized under law.
- Transcribing or duplicating part or all of this manual and/or this software without permission from our company is not permitted.
- As a part of our policy of continuous improvement, SHARP reserves the right to make design and specification changes for product improvement without prior notice.
- The screens and procedures are examples. The contents or details may vary depending on the screen configuration and OS version, etc. Windows 7 is used as an example in this manual.
- This manual does not contain basic operating instructions for Windows and Mac OS.

## Trademarks

- Microsoft and Windows are either registered trademarks or trademarks of Microsoft Corporation in the United States and/or other countries.
- Apple, App Store, Mac, and Mac OS are trademarks of Apple Inc., registered in the U.S. and other countries.
- Intel, Celeron, and Intel Core are trademarks or registered trademarks of Intel Corporation or its subsidiaries in the U.S.A. and other countries.
- MirrorOp is a registered trademark of Awind, Inc.
- Google, Android and Google Play are trademarks or registered trademarks of Google Inc.
- The trademark, Android, is used under license from Google Inc.
- The trademark, iOS, is used under license from Cisco Systems, Inc., in the U.S. and other countries.
- All other brand and product names are trademarks or registered trademarks of their respective holders.

# Introduction

## ■ Wireless

- On the monitor you can display a screen of a computer that is connected to the same network as the monitor's built-in wireless controller.
- You can display the screen by wireless LAN.

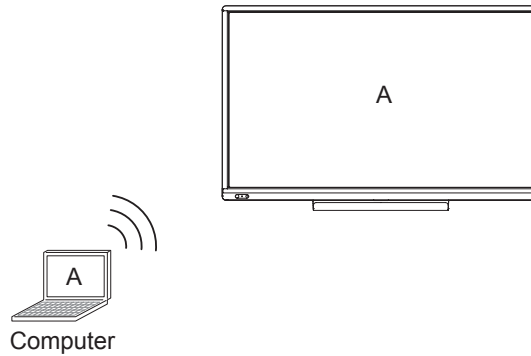

## ■ Simultaneous display

- You can display the screens of up to 4 computers at once.

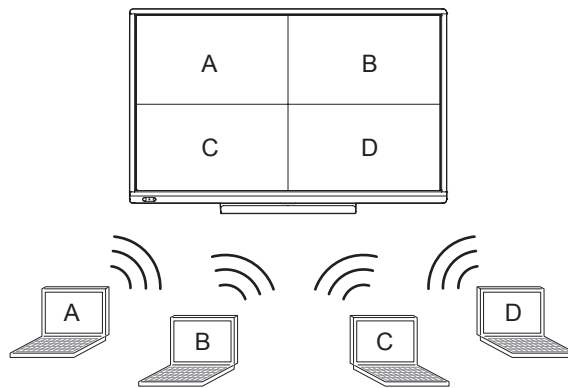

## ■ Direct Drawing

- You can use the monitor as a white board. (See page 32.)
- Using a touch pen, you can write on the displayed screen in Wireless mode. (See page 24.)

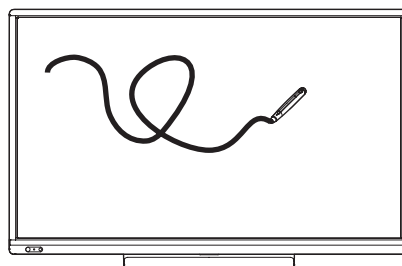

## ■ Conference control mode

- A conference admin can be designated to manage which computer screens are displayed. (See page 21.)

## ■ WebSlides

- The screen that is displayed in Wireless mode appears in the web browser of the computer that is connected to the wireless controller. (See page 22.)

### TIPS

- You can connect up to 10 devices to the wireless controller.
- The wireless LAN communication range is about 10 m.  
In the following cases, the communication speed may slow down or communication may not be possible.
  - An obstacle is present
  - Interference occurs with another wireless device using the same frequency
  - Electromagnetic interference occurs due to the magnetic field or static electricity of a microwave oven or other device
- The computer screen information is sent to the wireless controller and displayed on the monitor.  
For this reason, there may be a delay in the display or it may not be possible to display the screen correctly.  
Correct operation may not be possible from some applications.

### ! Caution

- To keep the performance of the wireless controller stable, put the monitor in the Power off (Standby mode) state once a day.

## System requirements for the computer to be connected

CPU	Intel Core 2 Duo 2.8 GHz or faster (Intel Core i5 or faster is recommended if audio and video will be used)
OS	Windows 7 (32-bit version / 64-bit version), Windows 8 (32-bit version / 64-bit version), Windows 8.1 (32-bit version / 64-bit version), Windows 10 (32-bit version / 64-bit version), Mac OS X v10.9, Mac OS X v10.10
Memory	At least 2 GB (4 GB or higher is recommended)
Free space on hard drive	At least 200 MB

### TIPS

- If you have an Android device, you can install and use MirrorOp Presenter by Awind, Inc. from the Google Play store.
- If you have an iOS device, you can install and use MirrorOp Presenter by Awind, Inc. from the App Store.
- For information about MirrorOp Presenter, contact Awind, Inc.

### ■ USB flash drives that can be used with the wireless controller

USB	2.0/3.0
File system	FAT/FAT32
Capacity	Up to 32 GB

- USB flash drives with approximate dimensions 12 mm (H) × 22 mm (W) × 60 mm (D)\* or less. (\*: Excluding the USB port)
- Do not use a USB flash drive that has a security function or write protection function.

### ! Caution

- Wait until processing has finished (a message appears) before removing the USB flash drive. Do not remove during processing (during access).

# Preparations

Connect the wireless controller and the computer.  
After connecting, configure wireless controller settings if needed to connect to an existing network.  
For details, consult your network administrator.

Connect the wireless adapter to the wireless controller. (See setup manual.)

## ■ Connecting only the wireless controller and the computer.

Directly connect the wireless controller and the computer by wireless LAN.  
When connecting for the first time, connect directly as well.

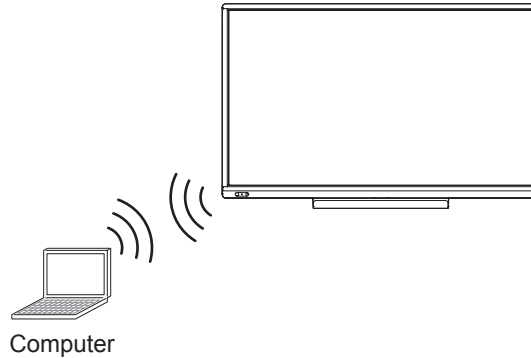

## ■ Connecting the wireless controller to an existing network by wired LAN

### If an access point already exists:

Connect the wireless controller to the existing network by wired LAN.  
Connect the computer to the wireless controller from an existing access point.

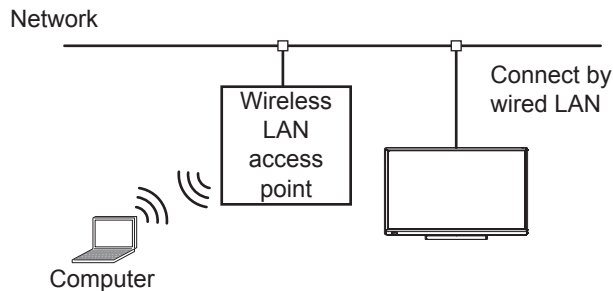

- Set the wireless controller appropriately for the existing network.

### If there is no access point:

Connect the wireless controller to the existing network by wired LAN.  
Connect the computer to the access point of the wireless controller.

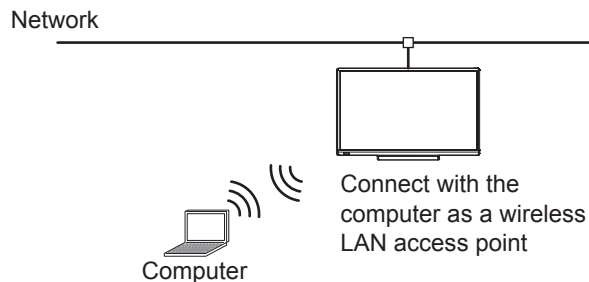

- Set the wireless controller appropriately for the existing network.
- Set the wireless controller to access point mode.
- \* The wireless LAN access point function of the wireless controller cannot be used when the monitor power is off.

## ■ Connecting the wireless controller to an existing network by wireless LAN

Connect the wireless controller and computer to an access point of the existing network by wireless LAN.

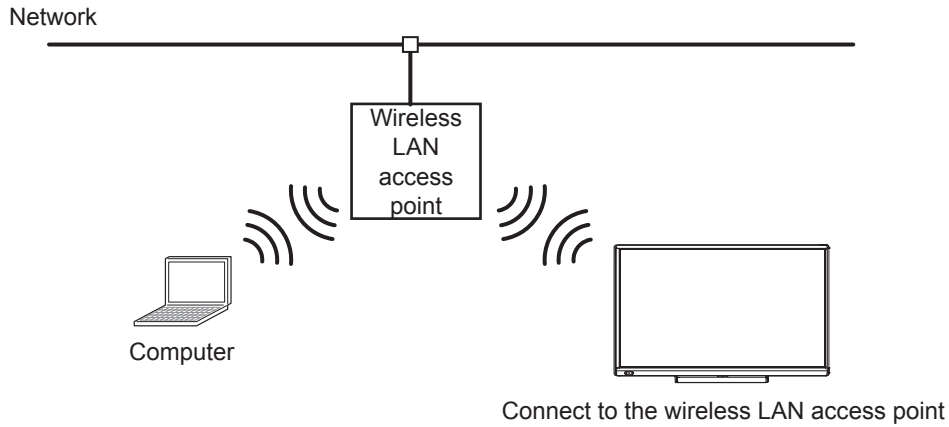

- Set the wireless controller appropriately for the existing network access point.
- Set the wireless controller to client mode. (See page 28.)

## ■ Using an existing network access point to display the screen of 1 computer on multiple monitors

You can display a screen on up to 4 monitors.

Connect the wireless controller to the existing network by wired LAN.

Connect the computer to the wireless controller from an existing access point.

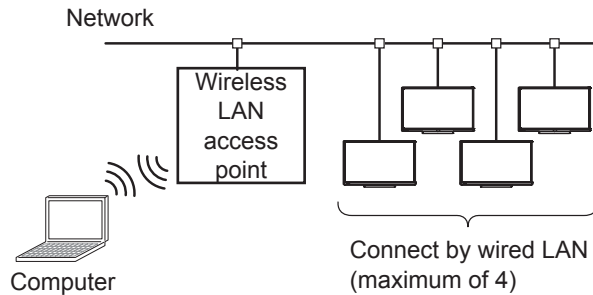

- Set the wireless controller appropriately for the existing network.

## Change the monitor to Wireless mode

1. Turn on the monitor power.
2. Change the input mode to “Wireless” with the input mode selection.

The home screen of Wireless mode appears.

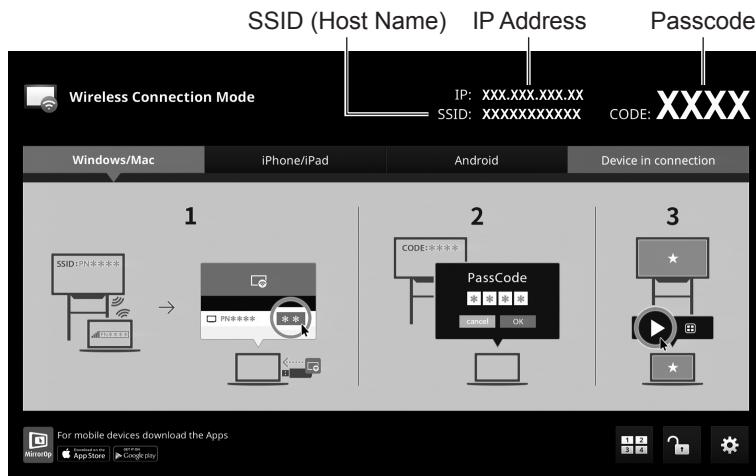

## Connect the computer to the wireless controller

Directly connect the computer to the wireless controller.

When using a different method, connection is necessary as well to change the settings from the factory default settings. In addition, read your computer’s manual.

### TIPS

- The factory default setting for the wireless controller’s wireless LAN is 2.4 GHz.

### ■ Windows

1. Click  on the taskbar.
2. Select the wireless controller from the wireless network list.

The SSID of the wireless controller is shown in the home screen of Wireless mode.



### ! Caution

- The factory default setting for wireless LAN security is not enabled. For security, set “Encryption” (encryption method) and a “Key”. (See page 10.)



## ■ Mac OS

1. Click “System Preferences” from the Apple menu (🍏).
2. Click “Network”.
3. Click “Wi-Fi” and select the wireless controller from the wireless network list.

The SSID of the wireless controller is shown in the home screen of Wireless mode.

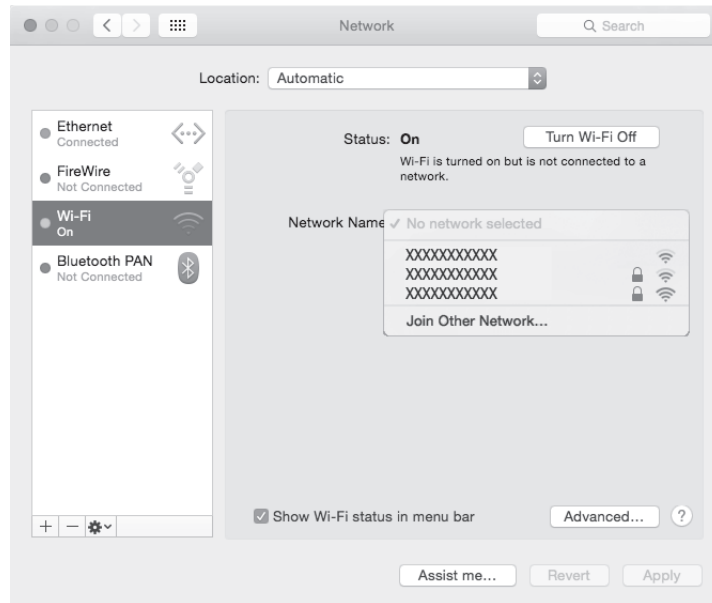

### ! Caution

- The factory default setting for wireless LAN security is not enabled. For security, set “Encryption” (encryption method) and a “Key”. (See page 10.)

## ■ Security and key settings

For wireless LAN security, set “Encryption” (encryption method) and a “Key”.

### TIPS

- A security warning may appear in some web browsers.  
Follow the instructions in the web browser and continue the procedure.

1. Start the computer’s web browser.
2. Enter the IP address shown on the home screen of Wireless mode in the address bar of the web browser.  
The settings screen appears.

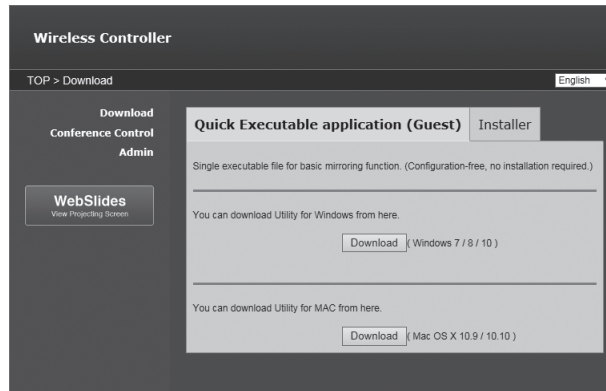

3. Click “Admin”.
4. Enter the password and click “Login”.  
The default password is “admin”.
5. Click “WLAN Setup”.
6. Set “Encryption” and a “Key”.
7. Click “Apply”.
8. Click “OK”.

Restart the wireless controller.

Connect the computer to the wireless controller. (See pages 8 and 9.)

For the security key, specify the key that you set in the above.

## MirrorOp for SHARP preparations

To display the computer screen on the monitor by wireless LAN, connection software (MirrorOp for SHARP) is required. The connection software is in the wireless token.

First read the software license agreement.

To use the connection software, you must agree to the software license agreement. For the software license agreement, refer to the file below in the wireless token.

\\Installer\EULA-EN.txt

There are 2 methods for using the connection software:

- Use the connection software in the wireless token
- Install the connection software on the computer to be used from the wireless token

For example,

- On computers that are not used frequently, you can use the connection software in the wireless token
- On frequently used computers, you can install the connection software

### TIPS

- To perform multi-touch, use the installed connection software.
- If you want to use a token for multiple computers at the same time, you can enable starting of the connection software from a commercially available USB flash drive. (See page 30.)

### ■ Connecting the wireless token

No preparations are needed. Start the connection software from the wireless token. (See page 12.)

### ■ Installing the connection software from the wireless token (Windows)

#### ! Caution

- This can only be done by a user with administrator authority.

#### 1. Connect the wireless token to the computer.

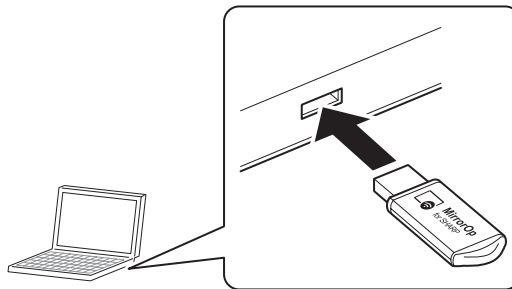

#### 2. Double-click the setup program in the wireless token.

\\Installer\Windows installer\SHMirrorOp\_Win\_inst.msi

#### 3. Follow the on-screen instructions.

- When the “User Account Control” screen appears, click “Yes” (or “Allow”).
- When a security warning screen (The publisher could not be verified.) appears, click “Allow”.

This completes the connection software installation procedure.

Next, start the connection software.

### TIPS

- The connection software can also be downloaded from the wireless controller to the computer. (See page 27.)

## ■ Installing the connection software from the wireless token (Mac OS)

### ! Caution

- To install, an administrator name (user name) and password are required.

### 1. Connect the wireless token to the computer.

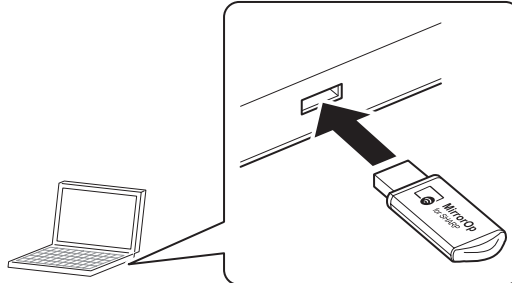

### 2. Double-click the installation file in the wireless token.

\\Installer\Mac installer\SHMirrorOp\_Mac.dmg

### 3. Drag the “SHMirrorOp\_Mac.app” icon to the “Applications” folder.

Follow the on-screen instructions.

- If a screen prompting you to enter the name and password appears, enter the name and password of the administrator and click “Install Software” (or “OK”).
- If the “When this software finishes installing, you must restart your computer. Are you sure you want to install the software now?” screen appears, click “Continue Installation”.

This completes the connection software installation procedure.  
Next, start the connection software.

### TIPS

- The connection software can also be downloaded from the wireless controller to the computer. (See page 27.)
- In some cases it may be necessary to install Sound Flower.pkg or Extend desktop.pkg.

---

## Start MirrorOp for SHARP

Start the connection software (MirrorOp for SHARP) on the computer, and connect to the wireless controller.

### ■ Starting from the wireless token

#### 1. Connect the wireless token to the computer.

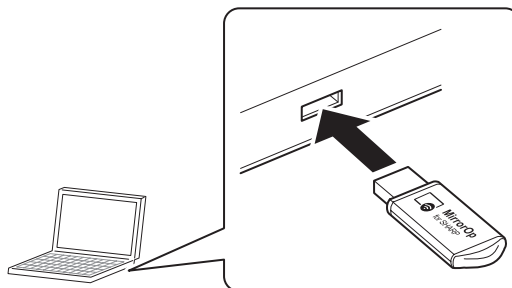

**2. Windows: Double-click “SHMirrorOp\_Win.exe” in the Autoplay screen.**

If the Autoplay screen does not appear, open the wireless token and double-click “SHMirrorOp\_Win.exe”.

**Mac: Open the wireless token and double-click “SHMirrorOp\_Mac.app”.**

The connection software starts.

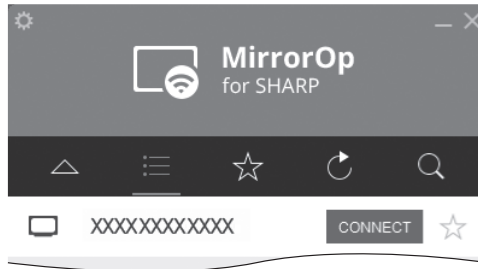

**3. Click “☰”, select the wireless controller to be connected, and click “CONNECT”.**

The host name of the wireless controller is shown in the home screen of Wireless mode.

**4. Enter the passcode and click “OK”.**

The passcode is shown in the home screen of Wireless mode.

The computer connects to the wireless controller.

**■ Starting from the installed/downloaded software**

**1. Double-click “MirrorOp for SHARP”.**

The connection software starts.

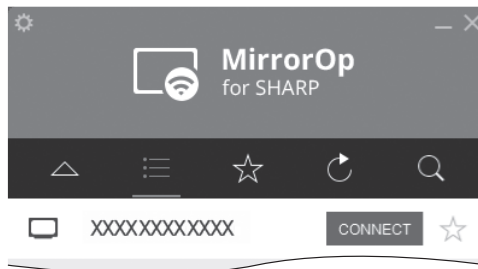

**2. Click “☰”, select the wireless controller to be connected, and click “CONNECT”.**

The host name of the wireless controller is shown in the home screen of Wireless mode.

**3. Enter the passcode and click “OK”.**

The passcode is shown in the home screen of Wireless mode.

The computer connects to the wireless controller.



**TIPS**

- The passcode changes for security.  
You can change the settings to make the passcode permanent, or connect without entering the passcode. (See page 27.)

# Wireless mode screen

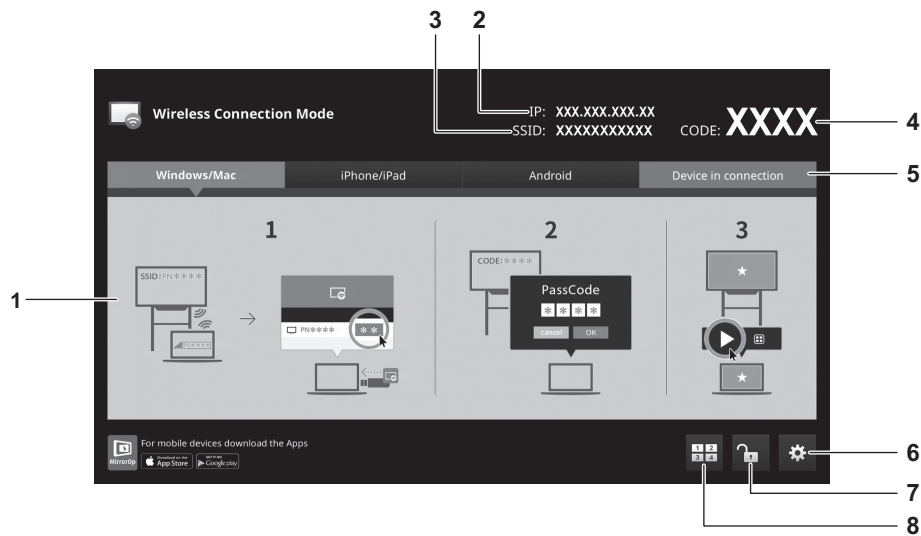
In the home screen that appears on the monitor in Wireless mode, you can select computers to be connected and set various functions.



1. Shows how to connect to the wireless controller.
2. Shows the IP address of the wireless controller.
3. Shows the SSID (Host Name) of the wireless controller.
4. Shows the passcode.
5. Show a list of the connected computers.
6. You can change the language used in the wireless controller screen.  
You can enable starting of the connection software from a commercially available USB flash drive. (See page 30.)
7. Specify whether or not a screen is displayed on the monitor by computer operation. The selection changes each time you touch this.  
 : Prohibit screen display by operation from another computer  
 : Allow screen display by operation from another computer
8. You can display the screens of up to 4 computers at once.

# Displaying the computer screen

## Operation from the monitor

Select the computer to be displayed from the computers that are currently connected to the wireless controller.

**1. Touch “Device in connection” in the home screen of Wireless mode.**

A list of the currently connected computers appears.

**2. Touch the computer to be displayed.**

The screen of the computer is displayed on the monitor.

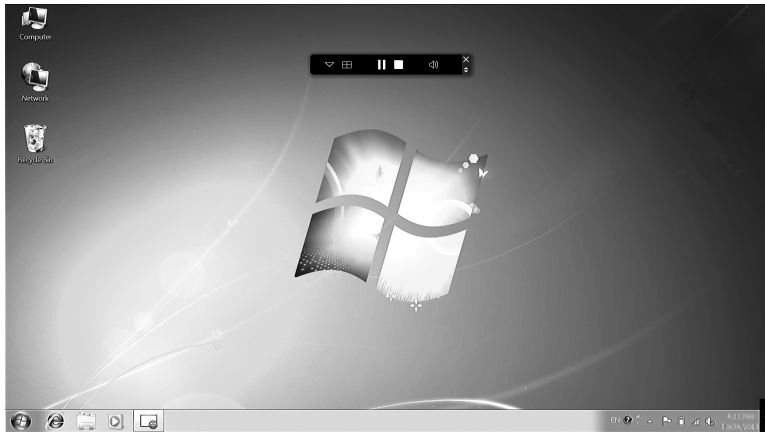

← Toolbar (See page 24.)

## Displaying multiple screens at once

You can display the screens of up to 4 computers at once.

The monitor screen is divided into 4 partitions, and you can select the computer that appears in each partition.

**1. Touch “Split Screen” (  ) in the home screen of Wireless mode.**

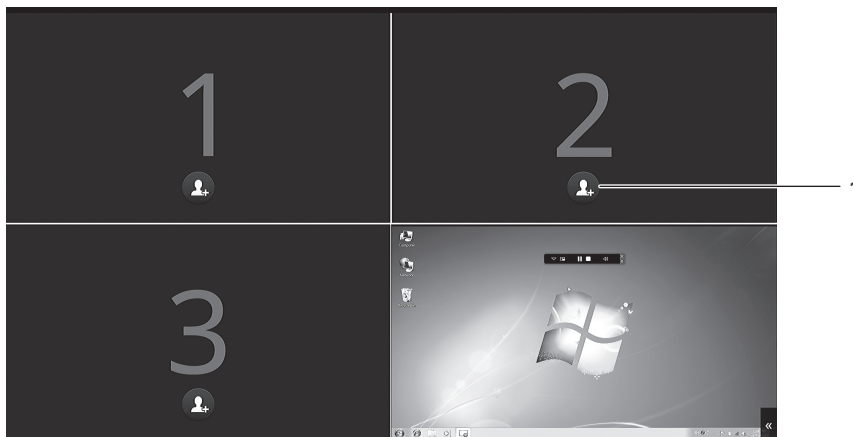

**1. Add User**

The computers that are currently connected appear. Select the computers to be displayed.

## Operation from the connection software

Operate from the connection software on the computer whose screen is displayed.

### TIPS

- Screen display by operation from the computer must be allowed. (🔒)
- You can also operate by touching the screen on the monitor.

#### 1. Click “Play” (▶) in the connection software.

The screen of the computer is displayed on the monitor.

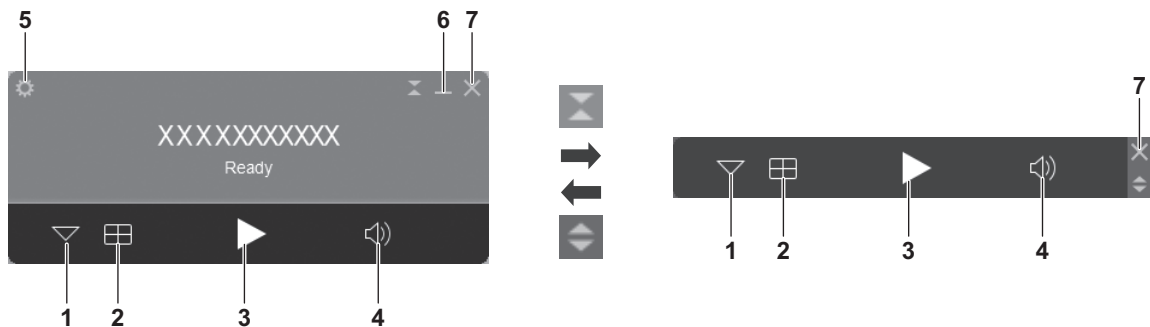
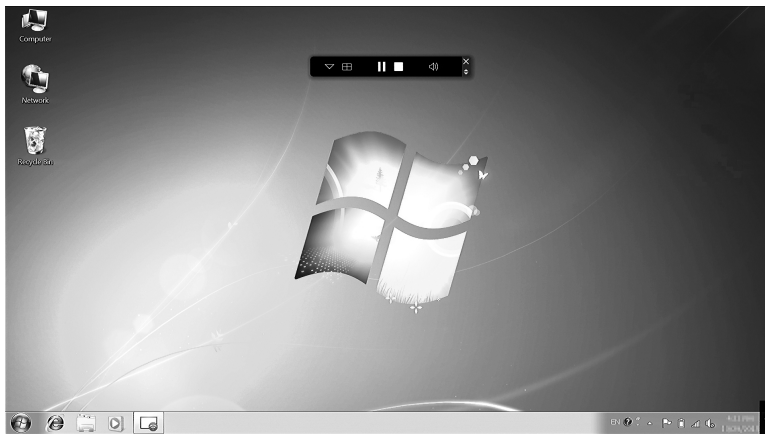

1.  Wireless controllers found from the computer appear. (See page 18.)
2. Split Screen  
Set 4-screen display.
3. Play  
The screen of the computer is displayed on the monitor.  
During screen display, “Stop” (◻) and “Pause” (▮▮) appear.
4. Mute  
Mute the audio of the currently connected device.  
Click when the audio is muted to unmute.
5. Menu  
Preferences : Configure settings for the connection software. (See page 19.)  
Capture & Save screen : Save the screen as an image file (JPEG). (See page 20.)  
Disconnect : Break the connection with the wireless controller.  
About : Display the version and license information of the connection software.  
Quit : Exit the connection software.
6. Minimize  
Minimize the operation screen.
7. Close  
Exit the connection software. (See page 26.)



## ■ Stopping the display

You can stop display of the computer screen on the monitor.

1. Click “Stop” (.
2. Return to the home screen of Wireless mode.

## ■ Pausing the display

You can pause the display of the computer screen on the monitor. When paused, the screen will not change even if an action is performed on the computer.

1. Click “Pause” (.
2. To resume the display, click “Play” (.

## ■ 4-screen display

1. Click “Split Screen” (.
2. Select the display location.

: Full-screen display / : Upper left display / : Upper right display / : Lower left display / : Lower right display

## ■ Connection software screen

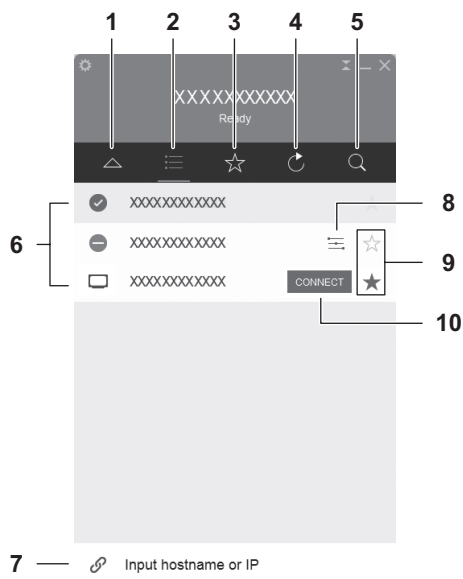

1.  Return to the operation screen.
2. Wireless controller list  
The wireless controllers (host name) found by the computer are displayed.
3. Favorites  
Wireless controllers (host name) that have been saved as favorites are displayed.
4. Refresh  
Refresh the list.
5. Search  
Search for a specified wireless controller in the list.
6. List  
The list of wireless controllers or favorites are displayed.
  - : Currently connected wireless controller
  - : Break the connection with the wireless controller.  
(Appears when you hover over the connected wireless controller with the mouse cursor.)
7. Host name / IP address input  
You can directly enter the host name or IP address of the desired wireless controller to connect the computer to that wireless controller.
8. Settings  
Start the web browser and configure wireless controller settings. (See page 27.)  
(Appears when you hover over the connected wireless controller with the mouse cursor.)
9. ☆ / ★  
To add a wireless controller to the favorites list, touch ☆ . (Appears as ★ )  
To delete a wireless controller from the favorites list, touch ★ . (Appears as ☆ )
10. CONNECT  
Connect the computer to the wireless controller.  
(Appears when you hover with the mouse cursor.)

## ■ Preferences

Configure connection software settings.

1. Click “Menu” (⚙️) in the connection software.
2. Click “Preferences”.

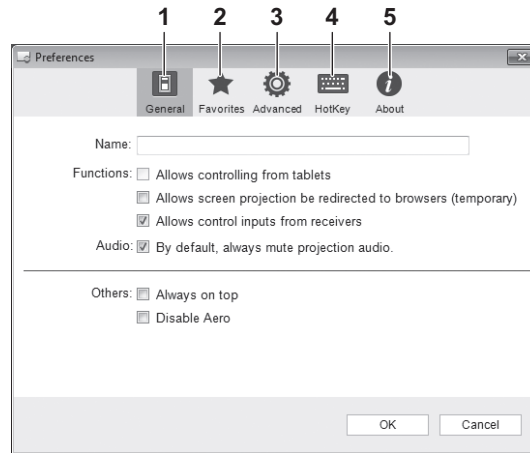

### 1. General

Name	Set the computer name used for connection to the wireless controller. Characters other than half-width alphanumeric characters may not display correctly.
Allows controlling from tablets	Select this to display the computer in the list screen of MirrorOp Receiver by Awind, Inc.
Allows screen projection be redirected to browsers (temporary)	Select to display the screen on another computer using the WebSlides function.
Allows control inputs from receivers	Select to enable operation of the computer displayed by wireless by touching the monitor.
By default, always mute projection audio.	Select to automatically mute the audio when displaying a computer screen on the monitor.
Always on top	Select to always move the connection software to the front.
Disable Aero	Select to disable Windows Aero.

### 2. Favorites

Default List	Set the default display for the connection software wireless controller list.
Import	Retrieve a wireless controller that has been saved.
Export	Save a wireless controller that has been added to the favorites.

### 3. Advanced

Mode	Set whether the desktop is duplicated or extended when displaying a computer screen on the monitor.
Quality	Set the image quality of the computer screen displayed on the monitor. When “Best” is set, more time may be required for processing.
Resolution Setting	Set the resolution of the computer screen displayed on the monitor. Always ask: Confirm the resolution each time a screen is displayed. Always change: Automatically change the resolution. Never ask: Display at the resolution of the computer desktop.
Aspect Ratio	Set whether the aspect ratio is adjusted to the screen or remains unchanged when a computer screen displayed on the monitor.
Encode Format	Set the data format used to send screen data. Normally “Automatic” should be used. “JPEG” is a high quality format, but increases the load on the network. “H.264” reduces the data size and lightens the load on the network.

4. HotKey

You can assign connection software actions to keyboard keys.

5. About

Display the version and license information of the connection software.

### ■ Saving the displayed screen as an image file

Save the currently displayed screen as an image file (JPEG).

An image file can only be saved from the computer that is displayed. Perform these steps from the computer that is being displayed.

1. Click “Menu” () in the connection software.
2. Click “Capture & Save screen”.
3. Specify a file name and save location, and click “Save”.

## Controlling the computer whose screen is displayed (Conference control mode)

When multiple computers are connected to the wireless controller, the computer whose screen is displayed and the display position can be controlled from one of the computers (Conference admin).

Perform these steps from the conference admin's computer.

**1. Start the computer's web browser.**

**2. Enter the IP address shown on the home screen of Wireless mode in the address bar of the web browser.**

The settings screen appears.

**3. Click "Conference Control".**

Enter the password and click "Login".

The default password is "moderator".

**4. Select the "Allow control from this page only." checkbox.**

You will only be able to control the display of computers whose checkboxes are selected.

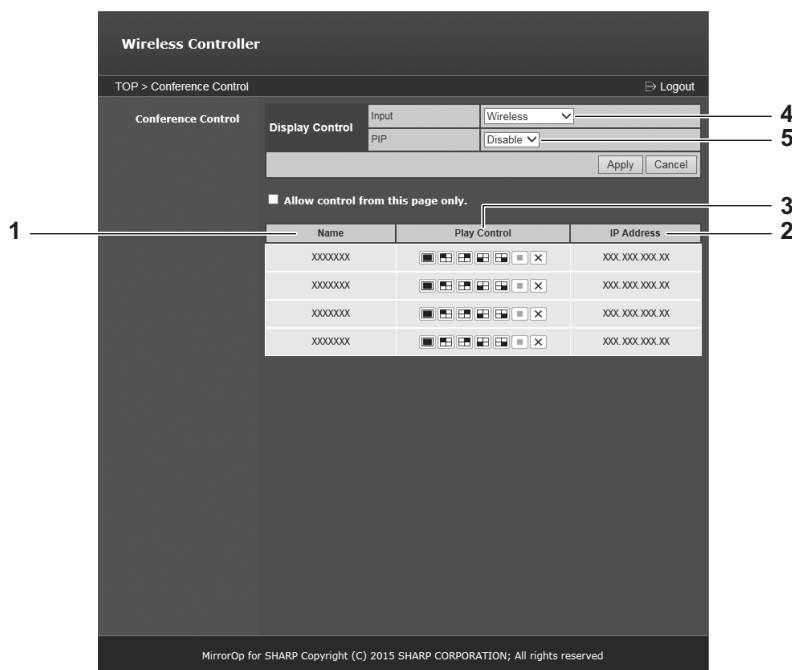

1. Computers connected to the wireless controller are shown.

2. The IP addresses of the computers connected to the wireless controller are shown.

3. Control display of each computer.

- : Full screen display
- : Display in upper left screen of four-screen display
- : Display in upper right screen of four-screen display
- : Display in lower left screen of four-screen display
- : Display in lower right screen of four-screen display
- : Stop display
- : Break connection

4. Change the input mode of the monitor.

5. Change the PIP mode of the monitor.

**5. When you are ready to exit, remove the checkmark from "Allow control from this page only.", and click "Logout".**

## Displaying the image in a web browser (WebSlides)

You can share a screen displayed in Wireless mode, and display the screen in the web browser on your computer.

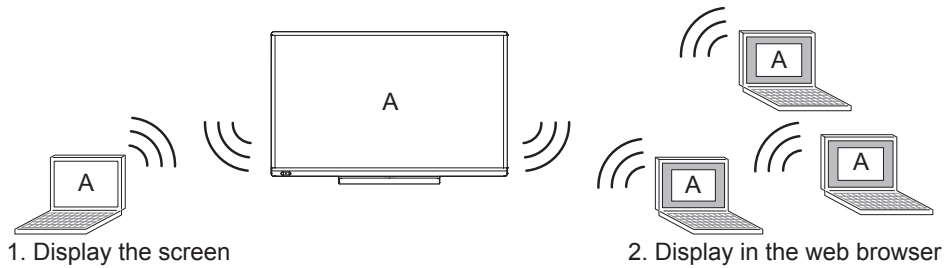

### TIPS

- “Allows screen projection be redirected to browsers (temporary)” must be selected in advance in the connection software settings of the computer whose screen is displayed (1. above). (See page 19.)
- A security warning may appear in some web browsers. Follow the instructions in the web browser and continue the procedure.

### ■ Viewing the screen from a web browser

Perform these steps on the computer whose screen you want to display (2. above).

1. **Start the computer’s web browser.**
2. **Enter the IP address shown on the home screen of Wireless mode in the address bar of the web browser.**  
The settings screen appears.
3. **Click “WebSlides”.**  
The screen displayed on the monitor is displayed.

### ■ WebSlides screen



1. Shows the screen that is displayed on the monitor.
2. Return to the settings screen.
3. Pause display of the screen. Even if the monitor display changes, the browser display will not change.
4. Save the currently displayed screen as an image file (JPEG).
5. Display at the screen size displayed on the monitor.
6. Fit the displayed screen to the size of the web browser window.
7. Refresh the screen display.
8. Set the display refresh interval.

## Displaying a computer screen on multiple monitors

You can display a computer screen on multiple wireless controllers on the same network. (Maximum of 4)  
We recommend that the wireless controllers be connected by wired LAN.

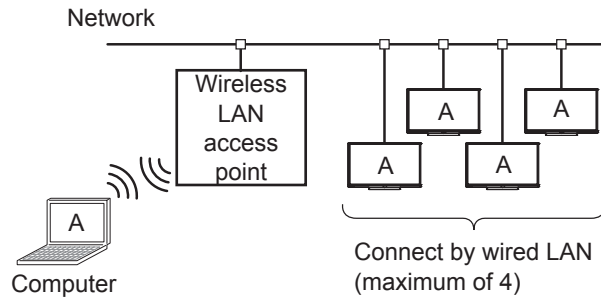

Perform these steps from the wireless controller list in the connection software. (See page 18.)

**1. Select the wireless controller to be connected, and click “CONNECT”.**

Do this for each wireless controller that you want to connect.

**2. Click “Play” (▶).**

# Actions when a screen is displayed

Using a touch pen, you can write in the screen.

## TIPS

- The touch operation mode varies depending on the connection software starting method and OS.

Starting method	OS	Touch Operation Mode
Start after installing	Windows 8 / 8.1 / 10	Multi-Touch Mode
	Windows 7 / Mac OS	Mouse Mode
Start from wireless token	Windows 7 / 8 / 8.1 / 10	Mouse Mode
Application downloaded from wireless controller	Mac OS	

- Incorrect operation may sometimes occur even when operating the computer by touching the monitor.
- The function buttons on the touch pen cannot be used. Multiple touch pens cannot be used at the same time.

## Drawing on the screen with a pen (Direct Drawing)

1. Touch "Toolbar" (⏪).

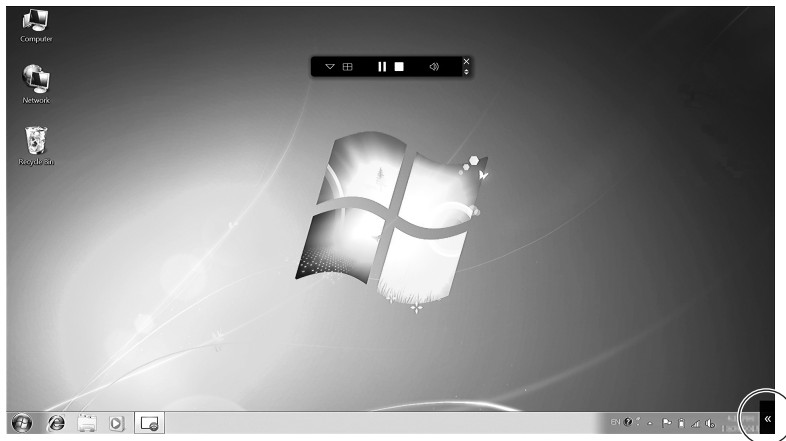

Display the toolbar.



1. Pen  
Draw a line on the screen.  
Touch while "Pen" is selected to change the thickness or color.
2. Mouse  
Activate mouse mode. You can operate the displayed computer by touch operation.
3. Eraser  
Touch on handwritten data to erase the data.  
Touch while "Eraser" is selected to change the size of the eraser.
4. Erase all  
Erase all handwritten data.
5. Save  
Save the currently displayed screen as an image file (JPEG).
6. Lock  
Touch to prevent the screen display from being changed from other computers.  
Touch again to unlock.
7. Home  
Return to the home screen of Wireless mode.



## TIPS

- You can erase handwritten data with the eraser.  
Touch the screen with the eraser, and after the cursor changes to the eraser, move the eraser.  
Touch on handwritten data to erase the data.

## ! Caution

- When the power is turned off, handwritten data is lost. Always save any handwritten data you need before turning off the power.
- Handwritten data will be lost if the display changes, such as when you display another computer or change to split screen display.  
You can lock the screen to prevent the display from changing.

## Saving the screen as an image file

You can save the screen and handwritten data displayed on the monitor as an image file (JPEG).  
You can save the image to the computer being displayed or to a USB flash drive connected to the wireless controller.

1. When saving the image to a USB flash drive, connect the USB flash drive to the wireless controller.

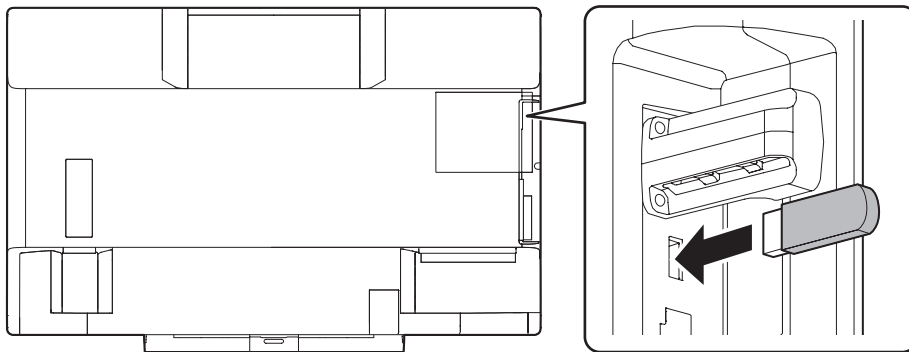

2. Touch “Save” (📁) on the toolbar.

When saving to a computer: Specify the save location and file name.

When saving to a USB flash drive: The file is saved with the file name “B0000001.jpg” in the “Annotation” folder of the USB flash drive.

(The number in the file name is successively incremented up to 9999999, after which it returns to 0000001.)

## ! Caution

- Set the correct date and time in the monitor. (See operation manual.)  
The monitor date and time is used for the file time stamp.

# Exiting

## ■ Exiting the connection software

1. Click "Close" (.

The connection software closes.

# Settings

Configure wireless controller settings.

## TIPS

- A security warning may appear in some web browsers.  
Follow the instructions in the web browser and continue the procedure.

1. Start the computer's web browser.
2. Enter the IP address shown on the home screen of Wireless mode in the address bar of the web browser.  
The settings screen appears.
3. When you have completed the settings, click "Apply".

## ■ Download

Quick Executable application (Guest)	Download the connection software in an executable state. Installation is not necessary.
Installer	Download the installer for the connection software. After downloading the installer to your computer, install the software.
Download Device Profile	Download the profile for connection of the wireless controller. If you are using the installed connection software, double-click the profile to connect the computer to the wireless controller from which the profile is downloaded.

## ■ Conference Control

The password entry screen appears.

Enter the password for Conference Control and click "Login". (The default password is "moderator".)

Display Control	Input	You can change the input mode of the monitor. After changing the mode, click "Apply".
	PIP	You can change the PIP mode of the monitor. After changing the mode, click "Apply".
Allow control from this page only.		Use in conference control mode. (See page 21.)

## ■ Admin

The password entry screen appears.

Enter the password for Admin and click "Login". (The default password is "admin".)

After changing the setting, click "Apply".

System Status		The system state is displayed. You can check the MAC address.
Device Setup	Device Setup	<b>Code</b> Set the passcode used to connect to the wireless controller. Disable: Connect to the wireless controller without entering a passcode. Random: The passcode changes. Use the following code: Fix to the numeric value entered for the passcode.
Network Setup	Host Name and Domain Name	<b>Host Name</b> Set the host name of the wireless controller. To use the same name as the SSID, select the "Same as WLAN Network name" checkbox. <b>Domain Name</b> Set the domain name of the wireless controller.
	IP Setup	<b>Obtain an IP address automatically</b> If the network has a DHCP server, set the IP address, subnet mask, default gateway, and DNS Server automatically. <b>Use the following IP address</b> Set the IP address, subnet mask, default gateway, and DNS Server manually.

Network Setup	DHCP Server Setup	<p><b>Auto</b> Use the DHCP server function of the wireless controller. Start IP / End IP: Specify the range of IP addresses assigned to clients by the wireless controller's DHCP server. Subnet Mask / Default Gateway / DNS Server: Specify the addresses that the wireless controller's DHCP server sets in the client.</p> <p><b>Disable</b> Do not use the DHCP server function of the wireless controller.</p>
	GateKeeper	<p>You can limit access to the wired LAN from computers connected to the wireless controller by wireless LAN. All Pass: Allow all access to the wired LAN. All Blocked: Block all access to the wired LAN. Internet Only: Only allow access by web browser.</p>
WLAN Setup	Wireless LAN	Set whether the wireless LAN function is used.
	Mode	<p>Access Point: Use the wireless controller as an access point. Station: Use the wireless controller as a client. AP and Station: Use the wireless controller as both an access point and a client.</p>
	Access Point	<p>Set this when the "Mode" is "Access Point" or "AP and Station".</p> <p><b>SSID</b> Set the SSID of the wireless controller.</p> <p><b>SSID Broadcast</b> Set whether SSID broadcast is used.</p> <p><b>Band</b> Set the frequency bands used for wireless LAN. * 2.4 GHz and 5 GHz cannot be used simultaneously. * When 5 GHz is selected, 2.4 GHz devices will not be able to connect.</p> <p><b>802.11mode</b> Change the communication frequency bands and the communication speed.</p> <p><b>Channel</b> Set the channels that are used for wireless LAN.</p> <p><b>Encryption</b> Set the encryption method for wireless LAN encryption.</p> <p><b>Key</b> Set a key that is appropriate for the wireless LAN encryption method.</p> <p><b>Channel Bandwidth</b> Set the channel bandwidth.</p>
	Station	<p>Set this when the "Mode" is "Station" or "AP and Station".</p> <p><b>Connect to Existing AP</b> Enter the SSID of the wireless LAN access point.</p> <p><b>Encryption</b> Set the encryption method for wireless LAN access point.</p> <p><b>Key</b> Set the encryption key that is appropriate for the wireless LAN access point.</p>

SNMP Setup	SNMP V3	<p><b><u>Enable / Disable</u></b> Set whether SNMP is enabled or disabled.</p> <p><b><u>Username</u></b> Set the user name for SNMP.</p> <p><b><u>Auth Password (MD5) / Priv Password (DES)</u></b> Set each password.</p> <p><b><u>Trap Destination</u></b> Set the trap destination.</p>
OSD Setup	Display Option	<p><b><u>Device Information / User-List / Connect info</u></b> Set whether each type of information is shown in the screen.</p> <p><b><u>Font color / Font Size</u></b> Set the color and size of the screen font.</p> <p><b><u>Screen Saver Settings</u></b> Set whether a screen saver is used. If used, set the time until the screen saver activates.</p>
	Projection Option	<p><b><u>OSD Menu Button</u></b> Set whether the toolbar is displayed.</p>
WebSlides Setup	Auto Refresh Interval (second)	Set the refresh interval for the screen displayed in the web browser.
	Access Password Control	Set the password for display of the screen in a web browser. Disable: Do not use a password. Use the same password as "Code": Use the same password as the passcode. Use the following Code: Use the entered number as the password.
Change Passwords	Conference Control	Change the password for Conference Control.
	Admin	Change the password for Admin.
Reset to Default		Return the wireless controller settings to their factory default state.
Firmware Upgrade	System Configuration	Export: You can save the settings. Import: You can retrieve saved settings.
	Firmware Upgrade	Update the firmware of the wireless controller.
Reboot System		Restart the wireless controller.

# Starting from a commercially available USB flash drive

You can enable starting of the connection software from a commercially available USB flash drive.

## USB flash drives that can be used:

- USB flash drives indicated on page 5 with a capacity of 128 MB or more.
- Use a USB flash drive in which nothing is saved.

### 1. Insert the USB flash drive into the USB port of the wireless controller.

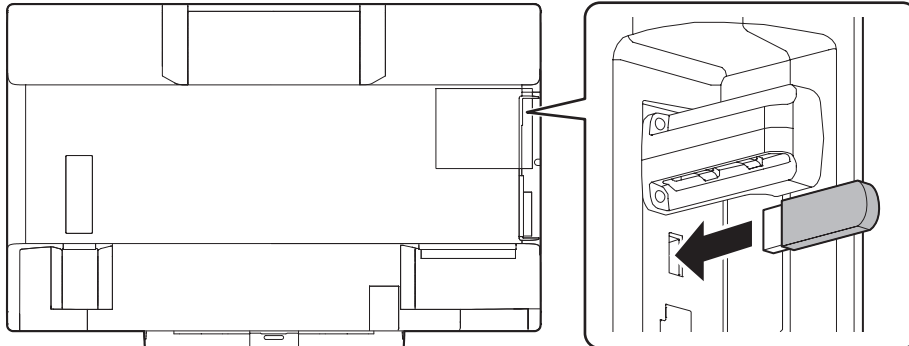

### 2. Touch “Setup” (⚙️) in the home screen of Wireless mode.

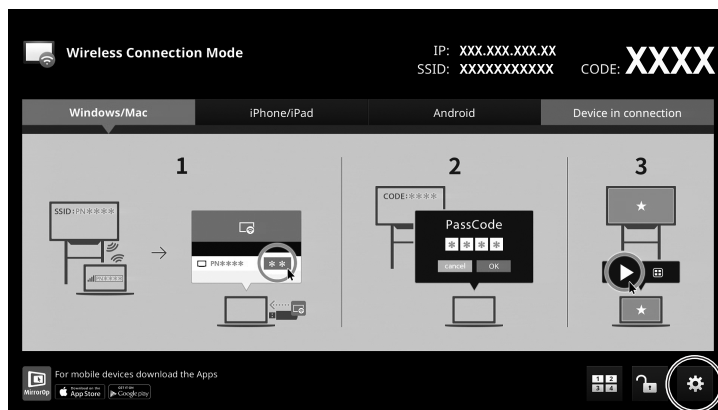

### 3. Touch “Make Token”.

Making starts.

### 4. When the making completed message appears, remove the USB flash drive.

#### ! Caution

- Do not remove the USB flash drive while making is in progress. And do not turn off the power of the monitor.
- Always create this on the wireless controller. Incorrect operation will result if you copy the file from the wireless token to the USB flash drive using your computer.

#### TIPS

- When the USB flash drive connection software is started, the software will automatically connect to the wireless controller on which the wireless token was created. (The software will also connect automatically over wireless LAN.)

# Uninstalling the connection software

## ■ Windows

### ! Caution

- This can only be done by a user with administrator authority.

1. **Exit all running software applications.**
2. **Select “Control Panel” from the “Start” menu.**
3. **Click “Uninstall a program”.**
  - If you are using icon view, click “Programs and Features”.
4. **Select “MirrorOp for SHARP” and click “Uninstall”.**
  - Follow the on-screen instructions.
  - When the “User Account Control” screen appears, click “Yes” (or “Allow”).

This completes the uninstallation.

## ■ Mac

### ! Caution

- To uninstall, an administrator name (user name) and password are required.

1. **Exit all running software applications.**
2. **Move “SHMirrorOp\_Mac.app” from the “Applications” folder to the recycle bin.**

This completes the uninstallation.

# Using as a whiteboard (Direct Drawing)

You can show a white background and use the monitor as a whiteboard.

## TIPS

- The function buttons on the touch pen cannot be used. Multiple touch pens cannot be used at the same time.

1. Turn on the monitor power.
2. Change the input mode to “Direct Drawing” with the input mode selection.

The whiteboard screen appears.

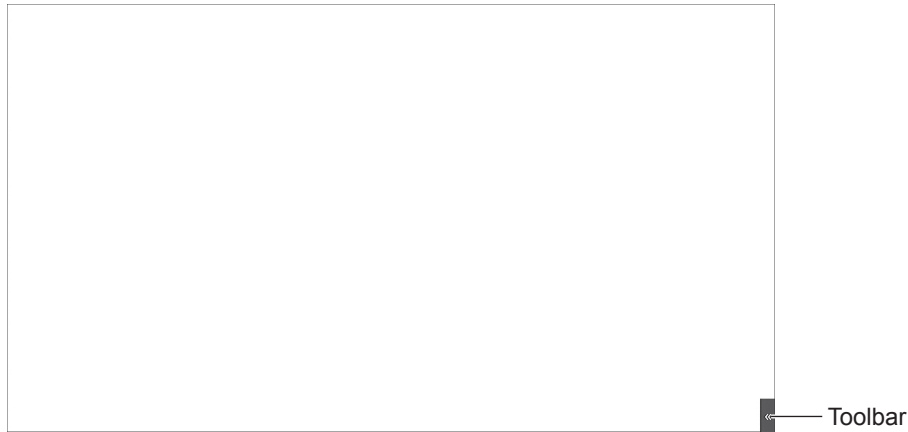

Touch “Toolbar” ( « ) to display the toolbar.

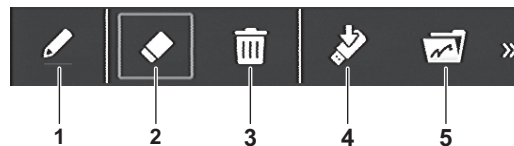

1. Pen  
Draw a line on the screen.  
Touch while “Pen” is selected to change the thickness or color.
2. Eraser  
Touch on handwritten data to erase the data.  
Touch while “Eraser” is selected to change the size of the eraser.
3. Erase all  
Erase all handwritten data.
4. Save  
Save the currently displayed screen as an image file (JPEG).
5. Open  
Display a saved image.  
This appears when a USB flash drive is connected.

## TIPS

- You can erase handwritten data with the eraser.  
Touch the screen with the eraser, and after the cursor changes to the eraser, move the eraser.  
Touch on handwritten data to erase the data.

## ! Caution

- When the power is turned off, handwritten data is lost. Always save any handwritten data you need before turning off the power.



## ■ Saving the screen in whiteboard as an image

The handwritten data in Direct Drawing mode can be saved as an image file (JPEG) in a USB flash drive connected to the wireless controller.

### 1. Connect the USB flash drive to the wireless controller.

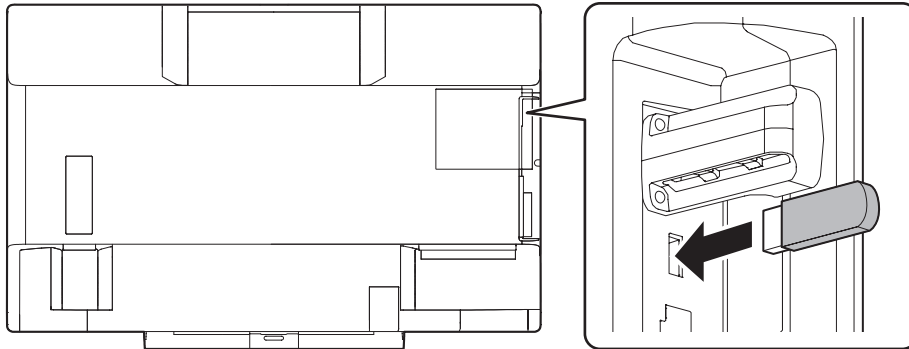

### 2. Touch “Save” (📁) on the toolbar.

The file is saved with the file name “B0000001.jpg” in the “Annotation” folder of the USB flash drive.  
(The number in the file name is successively incremented up to 9999999, after which it returns to 0000001.)

#### ! Caution

- Set the correct date and time in the monitor. (See operation manual.)  
The monitor date and time is used for the file time stamp.

## ■ Displaying a saved image

#### ! Caution

- If data already exists in Direct Drawing mode, the original data will be lost when the new image is displayed.

1. Connect the USB flash drive to the wireless controller. (See the description above.)
2. Touch “Open” (🖼️) on the toolbar.
3. Touch the image to be displayed.

# Intellectual Property Rights and Other Matters

## ■ Information on the software license for this product

### Software composition

The software included in this product is comprised of various software components whose individual copyrights are held by SHARP or by third parties.

### Software developed by SHARP and open source software

The copyrights for the software components and various relevant documents included with this product that were developed or written by SHARP are owned by SHARP and are protected by the Copyright Act, international treaties, and other relevant laws. This product also makes use of freely distributed software and software components whose copyrights are held by third parties. These include software components covered by a GNU General Public License (hereafter GPL), a GNU Lesser General Public License (hereafter LGPL) or other license agreement.

### Obtaining source code

Some of the open source software licensors require the distributor to provide the source code with the executable software components. GPL and LGPL include similar requirements. For information on obtaining the source code for the open source software and for obtaining the GPL, LGPL, and other license agreement information, visit the following website:

[http://www.sharp.co.jp/business/lcd-display/support/download/source\\_e.html](http://www.sharp.co.jp/business/lcd-display/support/download/source_e.html)

We are unable to answer any questions about the source code for the open source software. The source code for the software components whose copyrights are held by SHARP is not distributed.

### Acknowledgements

The following open source software components are included in this product:

busybox, lighttpd, bridge, glibc, wireless\_tools, iptables, Qt, Net-SNMP, Openssl, Dbus, nmbd, Mini-XML, udhcp, Linux Kernel, MedialInfo, libintl, libiconv, libcurl, zlib, USB/IP, SNMP++, soundflower, Noto Fonts, u-boot

## ■ Software copyrights

### Requirement to display license

The copyrights of some software components incorporated in the monitor require that the license be displayed. The licenses of these software components are shown below.

### BSD Licence

This product includes software developed by the University of California, Berkeley and its contributors.

### OpenSSL Licence

This product includes software developed by the OpenSSL Project for use in the OpenSSL Toolkit.  
(<http://www.openssl.org/>)

### OpenSSL LICENSE ISSUES

The OpenSSL toolkit stays under a dual license, i.e. both the conditions of the OpenSSL License and the original SSLeay license apply to the toolkit. See below for the actual license texts. Actually both licenses are BSD-style Open Source licenses. In case of any license issues related to OpenSSL please contact [openssl-core@openssl.org](mailto:openssl-core@openssl.org).

### OpenSSL License

Copyright (c) 1998-2011 The OpenSSL Project. All rights reserved.

Redistribution and use in source and binary forms, with or without modification, are permitted provided that the following conditions are met:

1. Redistributions of source code must retain the above copyright notice, this list of conditions and the following disclaimer.
2. Redistributions in binary form must reproduce the above copyright notice, this list of conditions and the following disclaimer in the documentation and/or other materials provided with the distribution.
3. All advertising materials mentioning features or use of this software must display the following acknowledgment:  
"This product includes software developed by the OpenSSL Project for use in the OpenSSL Toolkit. (<http://www.openssl.org/>)"
4. The names "OpenSSL Toolkit" and "OpenSSL Project" must not be used to endorse or promote products derived from this software without prior written permission. For written permission, please contact [openssl-core@openssl.org](mailto:openssl-core@openssl.org).
5. Products derived from this software may not be called "OpenSSL" nor may "OpenSSL" appear in their names without prior written permission of the OpenSSL Project.
6. Redistributions of any form whatsoever must retain the following acknowledgment:  
"This product includes software developed by the OpenSSL Project for use in the OpenSSL Toolkit (<http://www.openssl.org/>)"

THIS SOFTWARE IS PROVIDED BY THE OpenSSL PROJECT "AS IS" AND ANY EXPRESSED OR IMPLIED WARRANTIES, INCLUDING, BUT NOT LIMITED TO, THE IMPLIED WARRANTIES OF MERCHANTABILITY AND FITNESS FOR A PARTICULAR PURPOSE ARE DISCLAIMED. IN NO EVENT SHALL THE OpenSSL PROJECT OR ITS CONTRIBUTORS BE LIABLE FOR ANY DIRECT, INDIRECT, INCIDENTAL, SPECIAL, EXEMPLARY, OR CONSEQUENTIAL DAMAGES (INCLUDING, BUT NOT LIMITED TO, PROCUREMENT OF SUBSTITUTE GOODS OR SERVICES; LOSS OF USE, DATA, OR PROFITS; OR BUSINESS INTERRUPTION) HOWEVER CAUSED AND ON ANY THEORY OF LIABILITY, WHETHER IN CONTRACT, STRICT LIABILITY, OR TORT (INCLUDING NEGLIGENCE OR OTHERWISE) ARISING IN ANY WAY OUT OF THE USE OF THIS SOFTWARE, EVEN IF ADVISED OF THE POSSIBILITY OF SUCH DAMAGE.

This product includes cryptographic software written by Eric Young ([ey@cryptsoft.com](mailto:ey@cryptsoft.com)). This product includes software written by Tim Hudson ([tjh@cryptsoft.com](mailto:tjh@cryptsoft.com)).

### Original SSLeay License

Copyright (C) 1995-1998 Eric Young ([ey@cryptsoft.com](mailto:ey@cryptsoft.com))  
All rights reserved.

This package is an SSL implementation written by Eric Young ([ey@cryptsoft.com](mailto:ey@cryptsoft.com)).

The implementation was written so as to conform with Netscapes SSL.

This library is free for commercial and non-commercial use as long as the following conditions are adhered to. The following conditions apply to all code found in this distribution, be it the RC4, RSA, lhash, DES, etc., code; not just the SSL code. The SSL documentation included with this distribution is covered by the same copyright terms except that the holder is Tim Hudson (tjh@cryptsoft.com).

Copyright remains Eric Young's, and as such any Copyright notices in the code are not to be removed.

If this package is used in a product, Eric Young should be given attribution as the author of the parts of the library used.

This can be in the form of a textual message at program startup or in documentation (online or textual) provided with the package.

Redistribution and use in source and binary forms, with or without modification, are permitted provided that the following conditions are met:

1. Redistributions of source code must retain the copyright notice, this list of conditions and the following disclaimer.
2. Redistributions in binary form must reproduce the above copyright notice, this list of conditions and the following disclaimer in the documentation and/or other materials provided with the distribution.
3. All advertising materials mentioning features or use of this software must display the following acknowledgement:  
"This product includes cryptographic software written by Eric Young (eay@cryptsoft.com)"  
The word 'cryptographic' can be left out if the routines from the library being used are not cryptographic related :-).
4. If you include any Windows specific code (or a derivative thereof) from the apps directory (application code) you must include an acknowledgement:  
"This product includes software written by Tim Hudson (tjh@cryptsoft.com)"

THIS SOFTWARE IS PROVIDED BY ERIC YOUNG "AS IS" AND ANY EXPRESS OR IMPLIED WARRANTIES, INCLUDING, BUT NOT LIMITED TO, THE IMPLIED WARRANTIES OF MERCHANTABILITY AND FITNESS FOR A PARTICULAR PURPOSE ARE DISCLAIMED. IN NO EVENT SHALL THE AUTHOR OR CONTRIBUTORS BE LIABLE FOR ANY DIRECT, INDIRECT, INCIDENTAL, SPECIAL, EXEMPLARY, OR CONSEQUENTIAL DAMAGES (INCLUDING, BUT NOT LIMITED TO, PROCUREMENT OF SUBSTITUTE GOODS OR SERVICES; LOSS OF USE, DATA, OR PROFITS; OR BUSINESS INTERRUPTION) HOWEVER CAUSED AND ON ANY THEORY OF LIABILITY, WHETHER IN CONTRACT, STRICT LIABILITY, OR TORT (INCLUDING NEGLIGENCE OR OTHERWISE) ARISING IN ANY WAY OUT OF THE USE OF THIS SOFTWARE, EVEN IF ADVISED OF THE POSSIBILITY OF SUCH DAMAGE.

The licence and distribution terms for any publically available version or derivative of this code cannot be changed. i.e. this code cannot simply be copied and put under another distribution licence [including the GNU Public Licence.]

cURL  
COPYRIGHT AND PERMISSION NOTICE  
Copyright (c) 1996-2009, Daniel Stenberg,  
<daniel@haxx.se>  
All rights reserved.

Permission to use, copy, modify, and distribute this software for any purpose with or without fee is hereby granted, provided that the above copyright notice and this permission notice appear in all copies.

THE SOFTWARE IS PROVIDED "AS IS", WITHOUT WARRANTY OF ANY KIND, EXPRESS OR IMPLIED, INCLUDING BUT NOT LIMITED TO THE WARRANTIES OF MERCHANTABILITY, FITNESS FOR A PARTICULAR PURPOSE AND NONINFRINGEMENT OF THIRD PARTY RIGHTS. IN NO EVENT SHALL THE AUTHORS OR COPYRIGHT HOLDERS BE LIABLE FOR ANY CLAIM, DAMAGES OR OTHER LIABILITY, WHETHER IN AN ACTION OF CONTRACT, TORT OR OTHERWISE, ARISING FROM, OUT OF OR IN CONNECTION WITH THE SOFTWARE OR THE USE OR OTHER DEALINGS IN THE SOFTWARE.

Except as contained in this notice, the name of a copyright holder shall not be used in advertising or otherwise to promote the sale, use or other dealings in this Software without prior written authorization of the copyright holder.

UPnP  
Portions Copyright (C) 2004 Intel Corporation

GNU GENERAL PUBLIC LICENSE  
Version 2, June 1991

Copyright (C) 1989, 1991 Free Software Foundation, Inc.,  
51 Franklin Street, Fifth Floor, Boston, MA 02110-1301 USA  
Everyone is permitted to copy and distribute verbatim copies of this license document, but changing it is not allowed.

## Preamble

The licenses for most software are designed to take away your freedom to share and change it. By contrast, the GNU General Public License is intended to guarantee your freedom to share and change free software—to make sure the software is free for all its users. This General Public License applies to most of the Free Software Foundation's software and to any other program whose authors commit to using it. (Some other Free Software Foundation software is covered by the GNU Lesser General Public License instead.) You can apply it to your programs, too.

When we speak of free software, we are referring to freedom, not price. Our General Public Licenses are designed to make sure that you have the freedom to distribute copies of free software (and charge for this service if you wish), that you receive source code or can get it if you want it, that you can change the software or use pieces of it in new free programs; and that you know you can do these things.

To protect your rights, we need to make restrictions that forbid anyone to deny you these rights or to ask you to surrender the rights. These restrictions translate to certain responsibilities for you if you distribute copies of the software, or if you modify it.

For example, if you distribute copies of such a program, whether gratis or for a fee, you must give the recipients all the rights that you have. You must make sure that they, too, receive or can get the source code. And you must show them these terms so they know their rights.

We protect your rights with two steps: (1) copyright the software, and (2) offer you this license which gives you legal permission to copy, distribute and/or modify the software.

Also, for each author's protection and ours, we want to make certain that everyone understands that there is no warranty for this free software. If the software is modified by someone else and passed on, we want its recipients to know that what they have is not the original, so that any problems introduced by others will not reflect on the original authors' reputations.

Finally, any free program is threatened constantly by software patents. We wish to avoid the danger that redistributors of a free program will individually obtain patent licenses, in effect making the program proprietary. To prevent this, we have made it clear that any patent must be licensed for everyone's free use or not licensed at all.

The precise terms and conditions for copying, distribution and modification follow.

## GNU GENERAL PUBLIC LICENSE TERMS AND CONDITIONS FOR COPYING, DISTRIBUTION AND MODIFICATION

0. This License applies to any program or other work which contains a notice placed by the copyright holder saying it may be distributed under the terms of this General Public License. The "Program", below, refers to any such program or work, and a "work based on the Program" means either the Program or any derivative work under copyright law: that is to say, a work containing the Program or a portion of it, either verbatim or with modifications and/or translated into another language. (Hereinafter, translation is included without limitation in the term "modification".) Each licensee is addressed as "you".

Activities other than copying, distribution and modification are not covered by this License; they are outside its scope. The act of running the Program is not restricted, and the output from the Program is covered only if its contents constitute a work based on the Program (independent of having been made by running the Program).

Whether that is true depends on what the Program does.

1. You may copy and distribute verbatim copies of the Program's source code as you receive it, in any medium, provided that you conspicuously and appropriately publish on each copy an appropriate copyright notice and disclaimer of warranty; keep intact all the notices that refer to this License and to the absence of any warranty; and give any other recipients of the Program a copy of this License along with the Program.

You may charge a fee for the physical act of transferring a copy, and you may at your option offer warranty protection in exchange for a fee.

2. You may modify your copy or copies of the Program or any portion of it, thus forming a work based on the Program, and copy and distribute such modifications or work under the terms of Section 1 above, provided that you also meet all of these conditions:
  - a) You must cause the modified files to carry prominent notices stating that you changed the files and the date of any change.
  - b) You must cause any work that you distribute or publish, that in whole or in part contains or is derived from the Program or any part thereof, to be licensed as a whole at no charge to all third parties under the terms of this License.

- c) If the modified program normally reads commands interactively when run, you must cause it, when started running for such interactive use in the most ordinary way, to print or display an announcement including an appropriate copyright notice and a notice that there is no warranty (or else, saying that you provide a warranty) and that users may redistribute the program under these conditions, and telling the user how to view a copy of this License. (Exception: if the Program itself is interactive but does not normally print such an announcement, your work based on the Program is not required to print an announcement.)

These requirements apply to the modified work as a whole. If identifiable sections of that work are not derived from the Program, and can be reasonably considered independent and separate works in themselves, then this License, and its terms, do not apply to those sections when you distribute them as separate works. But when you distribute the same sections as part of a whole which is a work based on the Program, the distribution of the whole must be on the terms of this License, whose permissions for other licensees extend to the entire whole, and thus to each and every part regardless of who wrote it.

Thus, it is not the intent of this section to claim rights or contest your rights to work written entirely by you; rather, the intent is to exercise the right to control the distribution of derivative or collective works based on the Program.

In addition, mere aggregation of another work not based on the Program with the Program (or with a work based on the Program) on a volume of a storage or distribution medium does not bring the other work under the scope of this License.

3. You may copy and distribute the Program (or a work based on it, under Section 2) in object code or executable form under the terms of Sections 1 and 2 above provided that you also do one of the following:
- Accompany it with the complete corresponding machine-readable source code, which must be distributed under the terms of Sections 1 and 2 above on a medium customarily used for software interchange; or,
  - Accompany it with a written offer, valid for at least three years, to give any third party, for a charge no more than your cost of physically performing source distribution, a complete machine-readable copy of the corresponding source code, to be distributed under the terms of Sections 1 and 2 above on a medium customarily used for software interchange; or,
  - Accompany it with the information you received as to the offer to distribute corresponding source code. (This alternative is allowed only for noncommercial distribution and only if you received the program in object code or executable form with such an offer, in accord with Subsection b above.)

The source code for a work means the preferred form of the work for making modifications to it. For an executable work, complete source code means all the source code for all modules it contains, plus any associated interface definition files, plus the scripts used to control compilation and installation of the executable. However, as a special exception, the source code distributed need not include anything that is normally distributed (in either source or binary form) with the major components (compiler, kernel, and so on) of the operating system on which the executable runs, unless that component itself accompanies the executable.

If distribution of executable or object code is made by offering access to copy from a designated place, then offering equivalent access to copy the source code from the same place counts as distribution of the source code, even though third parties are not compelled to copy the source along with the object code.

4. You may not copy, modify, sublicense, or distribute the Program except as expressly provided under this License. Any attempt otherwise to copy, modify, sublicense or distribute the Program is void, and will automatically terminate your rights under this License. However, parties who have received copies, or rights, from you under this License will not have their licenses terminated so long as such parties remain in full compliance.
5. You are not required to accept this License, since you have not signed it. However, nothing else grants you permission to modify or distribute the Program or its derivative works. These actions are prohibited by law if you do not accept this License. Therefore, by modifying or distributing the Program (or any work based on the Program), you indicate your acceptance of this License to do so, and all its terms and conditions for copying, distributing or modifying the Program or works based on it.
6. Each time you redistribute the Program (or any work based on the Program), the recipient automatically receives a license from the original licensor to copy, distribute or modify the Program subject to these terms and conditions. You may not impose any further restrictions on the recipients' exercise of the rights granted herein. You are not responsible for enforcing compliance by third parties to this License.

7. If, as a consequence of a court judgment or allegation of patent infringement or for any other reason (not limited to patent issues), conditions are imposed on you (whether by court order, agreement or otherwise) that contradict the conditions of this License, they do not excuse you from the conditions of this License. If you cannot distribute so as to satisfy simultaneously your obligations under this License and any other pertinent obligations, then as a consequence you may not distribute the Program at all. For example, if a patent license would not permit royalty-free redistribution of the Program by all those who receive copies directly or indirectly through you, then the only way you could satisfy both it and this License would be to refrain entirely from distribution of the Program.

If any portion of this section is held invalid or unenforceable under any particular circumstance, the balance of the section is intended to apply and the section as a whole is intended to apply in other circumstances.

It is not the purpose of this section to induce you to infringe any patents or other property right claims or to contest validity of any such claims; this section has the sole purpose of protecting the integrity of the free software distribution system, which is implemented by public license practices. Many people have made generous contributions to the wide range of software distributed through that system in reliance on consistent application of that system; it is up to the author/donor to decide if he or she is willing to distribute software through any other system and a licensee cannot impose that choice.

This section is intended to make thoroughly clear what is believed to be a consequence of the rest of this License.

8. If the distribution and/or use of the Program is restricted in certain countries either by patents or by copyrighted interfaces, the original copyright holder who places the Program under this License may add an explicit geographical distribution limitation excluding those countries, so that distribution is permitted only in or among countries not thus excluded. In such case, this License incorporates the limitation as if written in the body of this License.
9. The Free Software Foundation may publish revised and/or new versions of the General Public License from time to time. Such new versions will be similar in spirit to the present version, but may differ in detail to address new problems or concerns.

Each version is given a distinguishing version number. If the Program specifies a version number of this License which applies to it and "any later version", you have the option of following the terms and conditions either of that version or of any later version published by the Free Software Foundation. If the Program does not specify a version number of this License, you may choose any version ever published by the Free Software Foundation.

10. If you wish to incorporate parts of the Program into other free programs whose distribution conditions are different, write to the author to ask for permission. For software which is copyrighted by the Free Software Foundation, write to the Free Software Foundation; we sometimes make exceptions for this. Our decision will be guided by the two goals of preserving the free status of all derivatives of our free software and of promoting the sharing and reuse of software generally.

#### NO WARRANTY

11. BECAUSE THE PROGRAM IS LICENSED FREE OF CHARGE, THERE IS NO WARRANTY FOR THE PROGRAM, TO THE EXTENT PERMITTED BY APPLICABLE LAW. EXCEPT WHEN OTHERWISE STATED IN WRITING THE COPYRIGHT HOLDERS AND/OR OTHER PARTIES PROVIDE THE PROGRAM "AS IS" WITHOUT WARRANTY OF ANY KIND, EITHER EXPRESSED OR IMPLIED, INCLUDING, BUT NOT LIMITED TO, THE IMPLIED WARRANTIES OF MERCHANTABILITY AND FITNESS FOR A PARTICULAR PURPOSE. THE ENTIRE RISK AS TO THE QUALITY AND PERFORMANCE OF THE PROGRAM IS WITH YOU. SHOULD THE PROGRAM PROVE DEFECTIVE, YOU ASSUME THE COST OF ALL NECESSARY SERVICING, REPAIR OR CORRECTION.
12. IN NO EVENT UNLESS REQUIRED BY APPLICABLE LAW OR AGREED TO IN WRITING WILL ANY COPYRIGHT HOLDER, OR ANY OTHER PARTY WHO MAY MODIFY AND/OR REDISTRIBUTE THE PROGRAM AS PERMITTED ABOVE, BE LIABLE TO YOU FOR DAMAGES, INCLUDING ANY GENERAL, SPECIAL, INCIDENTAL OR CONSEQUENTIAL DAMAGES ARISING OUT OF THE USE OR INABILITY TO USE THE PROGRAM (INCLUDING BUT NOT LIMITED TO LOSS OF DATA OR DATA BEING RENDERED INACCURATE OR LOSSES SUSTAINED BY YOU OR THIRD PARTIES OR A FAILURE OF THE PROGRAM TO OPERATE WITH ANY OTHER PROGRAMS), EVEN IF SUCH HOLDER OR OTHER PARTY HAS BEEN ADVISED OF THE POSSIBILITY OF SUCH DAMAGES.

#### END OF TERMS AND CONDITIONS

#### How to Apply These Terms to Your New Programs

If you develop a new program, and you want it to be of the greatest possible use to the public, the best way to achieve this is to make it free software which everyone can redistribute and change under these terms.

To do so, attach the following notices to the program. It is safest to attach them to the start of each source file to most effectively convey the exclusion of warranty; and each file should have at least the "copyright" line and a pointer to where the full notice is found.

```
<one line to give the program's name and a brief idea of what it does.>
Copyright (C) <year> <name of author>
```

This program is free software; you can redistribute it and/or modify it under the terms of the GNU General Public License as published by the Free Software Foundation; either version 2 of the License, or (at your option) any later version.

This program is distributed in the hope that it will be useful, but WITHOUT ANY WARRANTY; without even the implied warranty of MERCHANTABILITY or FITNESS FOR A PARTICULAR PURPOSE. See the GNU General Public License for more details.

You should have received a copy of the GNU General Public License along with this program; if not, write to the Free Software Foundation, Inc., 51 Franklin Street, Fifth Floor, Boston, MA 02110-1301 USA.

Also add information on how to contact you by electronic and paper mail.

If the program is interactive, make it output a short notice like this when it starts in an interactive mode:

```
Gnomovision version 69, Copyright (C) year name of author Gnomovision
comes with ABSOLUTELY NO WARRANTY; for details type 'show w'.
This is free software, and you are welcome to redistribute it under certain
conditions; type 'show c' for details.
```

The hypothetical commands 'show w' and 'show c' should show the appropriate parts of the General Public License. Of course, the commands you use may be called something other than 'show w' and 'show c'; they could even be mouse-clicks or menu items--whatever suits your program.

You should also get your employer (if you work as a programmer) or your school, if any, to sign a "copyright disclaimer" for the program, if necessary. Here is a sample; alter the names:

Yoyodyne, Inc., hereby disclaims all copyright interest in the program 'Gnomovision' (which makes passes at compilers) written by James Hacker.

```
<signature of Ty Coon>, 1 April 1989
Ty Coon, President of Vice
```

This General Public License does not permit incorporating your program into proprietary programs. If your program is a subroutine library, you may consider it more useful to permit linking proprietary applications with the library. If this is what you want to do, use the GNU Lesser General Public License instead of this License.

GNU LESSER GENERAL PUBLIC LICENSE  
Version 2.1, February 1999

Copyright (C) 1991, 1999 Free Software Foundation, Inc.  
51 Franklin Street, Fifth Floor, Boston, MA 02110-1301 USA  
Everyone is permitted to copy and distribute verbatim copies of this license document, but changing it is not allowed.

[This is the first released version of the Lesser GPL. It also counts as the successor of the GNU Library Public License, version 2, hence the version number 2.1.]

Preamble

The licenses for most software are designed to take away your freedom to share and change it. By contrast, the GNU General Public Licenses are intended to guarantee your freedom to share and change free software--to make sure the software is free for all its users.

This license, the Lesser General Public License, applies to some specially designated software packages--typically libraries--of the Free Software Foundation and other authors who decide to use it. You can use it too, but we suggest you first think carefully about whether this license or the ordinary General Public License is the better strategy to use in any particular case, based on the explanations below.

When we speak of free software, we are referring to freedom of use, not price. Our General Public Licenses are designed to make sure that you have the freedom to distribute copies of free software (and charge for this service if you wish); that you receive source code or can get it if you want it; that you can change the software and use pieces of it in new free programs; and that you are informed that you can do these things.

To protect your rights, we need to make restrictions that forbid distributors to deny you these rights or to ask you to surrender these rights. These restrictions translate to certain responsibilities for you if you distribute copies of the library or if you modify it.

For example, if you distribute copies of the library, whether gratis or for a fee, you must give the recipients all the rights that we gave you. You must make sure that they, too, receive or can get the source code. If you link other code with the library, you must provide complete object files to the recipients, so that they can relink them with the library after making changes to the library and recompiling it. And you must show them these terms so they know their rights.

We protect your rights with a two-step method: (1) we copyright the library, and (2) we offer you this license, which gives you legal permission to copy, distribute and/or modify the library.

To protect each distributor, we want to make it very clear that there is no warranty for the free library. Also, if the library is modified by someone else and passed on, the recipients should know that what they have is not the original version, so that the original author's reputation will not be affected by problems that might be introduced by others.

Finally, software patents pose a constant threat to the existence of any free program. We wish to make sure that a company cannot effectively restrict the users of a free program by obtaining a restrictive license from a patent holder. Therefore, we insist that any patent license obtained for a version of the library must be consistent with the full freedom of use specified in this license.

Most GNU software, including some libraries, is covered by the ordinary GNU General Public License. This license, the GNU Lesser General Public License, applies to certain designated libraries, and is quite different from the ordinary General Public License. We use this license for certain libraries in order to permit linking those libraries into non-free programs.

When a program is linked with a library, whether statically or using a shared library, the combination of the two is legally speaking a combined work, a derivative of the original library. The ordinary General Public License therefore permits such linking only if the entire combination fits its criteria of freedom. The Lesser General Public License permits more lax criteria for linking other code with the library.

We call this license the "Lesser" General Public License because it does Less to protect the user's freedom than the ordinary General Public License. It also provides other free software developers Less of an advantage over competing non-free programs. These disadvantages are the reason we use the ordinary General Public License for many libraries. However, the Lesser license provides advantages in certain special circumstances.

For example, on rare occasions, there may be a special need to encourage the widest possible use of a certain library, so that it becomes a de-facto standard. To achieve this, non-free programs must be allowed to use the library. A more frequent case is that a free library does the same job as widely used non-free libraries. In this case, there is little to gain by limiting the free library to free software only, so we use the Lesser General Public License.

In other cases, permission to use a particular library in non-free programs enables a greater number of people to use a large body of free software. For example, permission to use the GNU C Library in non-free programs enables many more people to use the whole GNU operating system, as well as its variant, the GNU/Linux operating system.

Although the Lesser General Public License is Less protective of the users' freedom, it does ensure that the user of a program that is linked with the Library has the freedom and the wherewithal to run that program using a modified version of the Library.

The precise terms and conditions for copying, distribution and modification follow. Pay close attention to the difference between a "work based on the library" and a "work that uses the library". The former contains code derived from the library, whereas the latter must be combined with the library in order to run.

GNU LESSER GENERAL PUBLIC LICENSE TERMS AND CONDITIONS FOR COPYING, DISTRIBUTION AND MODIFICATION

0. This License Agreement applies to any software library or other program which contains a notice placed by the copyright holder or other authorized party saying it may be distributed under the terms of this Lesser General Public License (also called "this License"). Each licensee is addressed as "you".

A "library" means a collection of software functions and/or data prepared so as to be conveniently linked with application programs (which use some of those functions and data) to form executables.

The "Library", below, refers to any such software library or work which has been distributed under these terms. A "work based on the Library" means either the Library or any derivative work under copyright law: that is to say, a work containing the Library or a portion of it, either verbatim or with modifications and/or translated straightforwardly into another language. (Hereinafter, translation is included without limitation in the term "modification".)

"Source code" for a work means the preferred form of the work for making modifications to it. For a library, complete source code means all the source code for all modules it contains, plus any associated interface definition files, plus the scripts used to control compilation and installation of the library.

Activities other than copying, distribution and modification are not covered by this License; they are outside its scope. The act of running a program using the Library is not restricted, and output from such a program is covered only if its contents constitute a work based on the Library (independent of the use of the Library in a tool for writing it). Whether that is true depends on what the Library does and what the program that uses the Library does.

1. You may copy and distribute verbatim copies of the Library's complete source code as you receive it, in any medium, provided that you conspicuously and appropriately publish on each copy an appropriate copyright notice and disclaimer of warranty; keep intact all the notices that refer to this License and to the absence of any warranty; and distribute a copy of this License along with the Library.

You may charge a fee for the physical act of transferring a copy, and you may at your option offer warranty protection in exchange for a fee.

2. You may modify your copy or copies of the Library or any portion of it, thus forming a work based on the Library, and copy and distribute such modifications or work under the terms of Section 1 above, provided that you also meet all of these conditions:
  - a) The modified work must itself be a software library.
  - b) You must cause the files modified to carry prominent notices stating that you changed the files and the date of any change.
  - c) You must cause the whole of the work to be licensed at no charge to all third parties under the terms of this License.
  - d) If a facility in the modified Library refers to a function or a table of data to be supplied by an application program that uses the facility, other than as an argument passed when the facility is invoked, then you must make a good faith effort to ensure that, in the event an application does not supply such function or table, the facility still operates, and performs whatever part of its purpose remains meaningful.

(For example, a function in a library to compute square roots has a purpose that is entirely well-defined independent of the application. Therefore, Subsection 2d requires that any application-supplied function or table used by this function must be optional: if the application does not supply it, the square root function must still compute square roots.)

These requirements apply to the modified work as a whole. If identifiable sections of that work are not derived from the Library, and can be reasonably considered independent and separate works in themselves, then this License, and its terms, do not apply to those sections when you distribute them as separate works. But when you distribute the same sections as part of a whole which is a work based on the Library, the distribution of the whole must be on the terms of this License, whose permissions for other licensees extend to the entire whole, and thus to each and every part regardless of who wrote it.

Thus, it is not the intent of this section to claim rights or contest your rights to work written entirely by you; rather, the intent is to exercise the right to control the distribution of derivative or collective works based on the Library.

In addition, mere aggregation of another work not based on the Library with the Library (or with a work based on the Library) on a volume of a storage or distribution medium does not bring the other work under the scope of this License.

3. You may opt to apply the terms of the ordinary GNU General Public License instead of this License to a given copy of the Library. To do this, you must alter all the notices that refer to this License, so that they refer to the ordinary GNU General Public License, version 2, instead of to this License. (If a newer version than version 2 of the ordinary GNU General Public License has appeared, then you can specify that version instead if you wish.) Do not make any other change in these notices.

Once this change is made in a given copy, it is irreversible for that copy, so the ordinary GNU General Public License applies to all subsequent copies and derivative works made from that copy.

This option is useful when you wish to copy part of the code of the Library into a program that is not a library.

4. You may copy and distribute the Library (or a portion or derivative of it, under Section 2) in object code or executable form under the terms of Sections 1 and 2 above provided that you accompany it with the complete corresponding machine-readable source code, which must be distributed under the terms of Sections 1 and 2 above on a medium customarily used for software interchange.

If distribution of object code is made by offering access to copy from a designated place, then offering equivalent access to copy the source code from the same place satisfies the requirement to distribute the source code, even though third parties are not compelled to copy the source along with the object code.

5. A program that contains no derivative of any portion of the Library, but is designed to work with the Library by being compiled or linked with it, is called a "work that uses the Library". Such a work, in isolation, is not a derivative work of the Library, and therefore falls outside the scope of this License.

However, linking a "work that uses the Library" with the Library creates an executable that is a derivative of the Library (because it contains portions of the Library), rather than a "work that uses the library". The executable is therefore covered by this License. Section 6 states terms for distribution of such executables.

When a "work that uses the Library" uses material from a header file that is part of the Library, the object code for the work may be a derivative work of the Library even though the source code is not. Whether this is true is especially significant if the work can be linked without the Library, or if the work is itself a library. The threshold for this to be true is not precisely defined by law.

If such an object file uses only numerical parameters, data structure layouts and accessors, and small macros and small inline functions (ten lines or less in length), then the use of the object file is unrestricted, regardless of whether it is legally a derivative work. (Executables containing this object code plus portions of the Library will still fall under Section 6.)

Otherwise, if the work is a derivative of the Library, you may distribute the object code for the work under the terms of Section 6. Any executables containing that work also fall under Section 6, whether or not they are linked directly with the Library itself.

6. As an exception to the Sections above, you may also combine or link a "work that uses the Library" with the Library to produce a work containing portions of the Library, and distribute that work under terms of your choice, provided that the terms permit modification of the work for the customer's own use and reverse engineering for debugging such modifications.

You must give prominent notice with each copy of the work that the Library is used in it and that the Library and its use are covered by this License. You must supply a copy of this License. If the work during execution displays copyright notices, you must include the copyright notice for the Library among them, as well as a reference directing the user to the copy of this License. Also, you must do one of these things:

- a) Accompany the work with the complete corresponding machine-readable source code for the Library including whatever changes were used in the work (which must be distributed under Sections 1 and 2 above); and, if the work is an executable linked with the Library, with the complete machine-readable "work that uses the Library", as object code and/or source code, so that the user can modify the Library and then relink to produce a modified executable containing the modified Library. (It is understood that the user who changes the contents of definitions files in the Library will not necessarily be able to recompile the application to use the modified definitions.)
- b) Use a suitable shared library mechanism for linking with the Library. A suitable mechanism is one that (1) uses at run time a copy of the library already present on the user's computer system, rather than copying library functions into the executable, and (2) will operate properly with a modified version of the library, if the user installs one, as long as the modified version is interface-compatible with the version that the work was made with.
- c) Accompany the work with a written offer, valid for at least three years, to give the same user the materials specified in Subsection 6a, above, for a charge no more than the cost of performing this distribution.
- d) If distribution of the work is made by offering access to copy from a designated place, offer equivalent access to copy the above specified materials from the same place.
- e) Verify that the user has already received a copy of these materials or that you have already sent this user a copy.

For an executable, the required form of the "work that uses the Library" must include any data and utility programs needed for reproducing the executable from it. However, as a special exception, the materials to be distributed need not include anything that is normally distributed (in either source or binary form) with the major components (compiler, kernel, and so on) of the operating system on which the executable runs, unless that component itself accompanies the executable.

It may happen that this requirement contradicts the license restrictions of other proprietary libraries that do not normally accompany the operating system. Such a contradiction means you cannot use both them and the Library together in an executable that you distribute.

7. You may place library facilities that are a work based on the Library side-by-side in a single library together with other library facilities not covered by this License, and distribute such a combined library, provided that the separate distribution of the work based on the Library and of the other library facilities is otherwise permitted, and provided that you do these two things:

- a) Accompany the combined library with a copy of the same work based on the Library, uncombined with any other library facilities. This must be distributed under the terms of the Sections above.
- b) Give prominent notice with the combined library of the fact that part of it is a work based on the Library, and explaining where to find the accompanying uncombined form of the same work.

8. You may not copy, modify, sublicense, link with, or distribute the Library except as expressly provided under this License. Any attempt otherwise to copy, modify, sublicense, link with, or distribute the Library is void, and will automatically terminate your rights under this License. However, parties who have received copies, or rights, from you under this License will not have their licenses terminated so long as such parties remain in full compliance.

9. You are not required to accept this License, since you have not signed it. However, nothing else grants you permission to modify or distribute the Library or its derivative works. These actions are prohibited by law if you do not accept this License. Therefore, by modifying or distributing the Library (or any work based on the Library), you indicate your acceptance of this License to do so, and all its terms and conditions for copying, distributing or modifying the Library or works based on it.

10. Each time you redistribute the Library (or any work based on the Library), the recipient automatically receives a license from the original licensor to copy, distribute, link with or modify the Library subject to these terms and conditions. You may not impose any further restrictions on the recipients' exercise of the rights granted herein. You are not responsible for enforcing compliance by third parties with this License.

11. If, as a consequence of a court judgment or allegation of patent infringement or for any other reason (not limited to patent issues), conditions are imposed on you (whether by court order, agreement or otherwise) that contradict the conditions of this License, they do not excuse you from the conditions of this License. If you cannot distribute so as to satisfy simultaneously your obligations under this License and any other pertinent obligations, then as a consequence you may not distribute the Library at all. For example, if a patent license would not permit royalty-free redistribution of the Library by all those who receive copies directly or indirectly through you, then the only way you could satisfy both it and this License would be to refrain entirely from distribution of the Library.

If any portion of this section is held invalid or unenforceable under any particular circumstance, the balance of the section is intended to apply, and the section as a whole is intended to apply in other circumstances.

It is not the purpose of this section to induce you to infringe any patents or other property right claims or to contest validity of any such claims; this section has the sole purpose of protecting the integrity of the free software distribution system which is implemented by public license practices. Many people have made generous contributions to the wide range of software distributed through that system in reliance on consistent application of that system; it is up to the author/donor to decide if he or she is willing to distribute software through any other system and a licensee cannot impose that choice.

This section is intended to make thoroughly clear what is believed to be a consequence of the rest of this License.

12. If the distribution and/or use of the Library is restricted in certain countries either by patents or by copyrighted interfaces, the original copyright holder who places the Library under this License may add an explicit geographical distribution limitation excluding those countries, so that distribution is permitted only in or among countries not thus excluded. In such case, this License incorporates the limitation as if written in the body of this License.

13. The Free Software Foundation may publish revised and/or new versions of the Lesser General Public License from time to time. Such new versions will be similar in spirit to the present version, but may differ in detail to address new problems or concerns.

Each version is given a distinguishing version number. If the Library specifies a version number of this License which applies to it and "any later version", you have the option of following the terms and conditions either of that version or of any later version published by the Free Software Foundation. If the Library does not specify a license version number, you may choose any version ever published by the Free Software Foundation.

14. If you wish to incorporate parts of the Library into other free programs whose distribution conditions are incompatible with these, write to the author to ask for permission. For software which is copyrighted by the Free Software Foundation, write to the Free Software Foundation; we sometimes make exceptions for this. Our decision will be guided by the two goals of preserving the free status of all derivatives of our free software and of promoting the sharing and reuse of software generally.

#### NO WARRANTY

15. BECAUSE THE LIBRARY IS LICENSED FREE OF CHARGE, THERE IS NO WARRANTY FOR THE LIBRARY, TO THE EXTENT PERMITTED BY APPLICABLE LAW.

EXCEPT WHEN OTHERWISE STATED IN WRITING THE COPYRIGHT HOLDERS AND/OR OTHER PARTIES PROVIDE THE LIBRARY "AS IS" WITHOUT WARRANTY OF ANY KIND, EITHER EXPRESSED OR IMPLIED, INCLUDING, BUT NOT LIMITED TO, THE IMPLIED WARRANTIES OF MERCHANTABILITY AND FITNESS FOR A PARTICULAR PURPOSE. THE ENTIRE RISK AS TO THE QUALITY AND PERFORMANCE OF THE LIBRARY IS WITH YOU. SHOULD THE LIBRARY PROVE DEFECTIVE, YOU ASSUME THE COST OF ALL NECESSARY SERVICING, REPAIR OR CORRECTION.

16. IN NO EVENT UNLESS REQUIRED BY APPLICABLE LAW OR AGREED TO IN WRITING WILL ANY COPYRIGHT HOLDER, OR ANY OTHER PARTY WHO MAY MODIFY AND/OR REDISTRIBUTE THE LIBRARY AS PERMITTED ABOVE, BE LIABLE TO YOU FOR DAMAGES, INCLUDING ANY GENERAL, SPECIAL, INCIDENTAL OR CONSEQUENTIAL DAMAGES ARISING OUT OF THE USE OR INABILITY TO USE THE LIBRARY (INCLUDING BUT NOT LIMITED TO LOSS OF DATA OR DATA BEING RENDERED INACCURATE OR LOSSES SUSTAINED BY YOU OR THIRD PARTIES OR A FAILURE OF THE LIBRARY TO OPERATE WITH ANY OTHER SOFTWARE), EVEN IF SUCH HOLDER OR OTHER PARTY HAS BEEN ADVISED OF THE POSSIBILITY OF SUCH DAMAGES.

#### END OF TERMS AND CONDITIONS

#### How to Apply These Terms to Your New Libraries

If you develop a new library, and you want it to be of the greatest possible use to the public, we recommend making it free software that everyone can redistribute and change. You can do so by permitting redistribution under these terms (or, alternatively, under the terms of the ordinary General Public License).

To apply these terms, attach the following notices to the library. It is safest to attach them to the start of each source file to most effectively convey the exclusion of warranty; and each file should have at least the "copyright" line and a pointer to where the full notice is found.

<one line to give the library's name and a brief idea of what it does.>  
Copyright (C) <year> <name of author>

This library is free software; you can redistribute it and/or modify it under the terms of the GNU Lesser General Public License as published by the Free Software Foundation; either version 2.1 of the License, or (at your option) any later version.

This library is distributed in the hope that it will be useful, but WITHOUT ANY WARRANTY; without even the implied warranty of MERCHANTABILITY or FITNESS FOR A PARTICULAR PURPOSE. See the GNU Lesser General Public License for more details.

You should have received a copy of the GNU Lesser General Public License along with this library; if not, write to the Free Software Foundation, Inc., 51 Franklin Street, Fifth Floor, Boston, MA 02110-1301 USA

Also add information on how to contact you by electronic and paper mail.

You should also get your employer (if you work as a programmer) or your school, if any, to sign a "copyright disclaimer" for the library, if necessary. Here is a sample; alter the names:

Yoyodyne, Inc., hereby disclaims all copyright interest in the library 'Frob' (a library for tweaking knobs) written by James Random Hacker.

<signature of Ty Coon>, 1 April 1990  
Ty Coon, President of Vice

That's all there is to it!

lighttpd  
Copyright (c) 2004, Jan Kneschke, incremental  
All rights reserved.

Redistribution and use in source and binary forms, with or without modification, are permitted provided that the following conditions are met:

- Redistributions of source code must retain the above copyright notice, this list of conditions and the following disclaimer.
- Redistributions in binary form must reproduce the above copyright notice, this list of conditions and the following disclaimer in the documentation and/or other materials provided with the distribution.
- Neither the name of the 'incremental' nor the names of its contributors may be used to endorse or promote products derived from this software without specific prior written permission.

THIS SOFTWARE IS PROVIDED BY THE COPYRIGHT HOLDERS AND CONTRIBUTORS "AS IS" AND ANY EXPRESS OR IMPLIED WARRANTIES, INCLUDING, BUT NOT LIMITED TO, THE IMPLIED WARRANTIES OF MERCHANTABILITY AND FITNESS FOR A PARTICULAR PURPOSE ARE DISCLAIMED. IN NO EVENT SHALL THE COPYRIGHT OWNER OR CONTRIBUTORS BE LIABLE FOR ANY DIRECT, INDIRECT, INCIDENTAL, SPECIAL, EXEMPLARY, OR CONSEQUENTIAL DAMAGES (INCLUDING, BUT NOT LIMITED TO, PROCUREMENT OF SUBSTITUTE GOODS OR SERVICES; LOSS OF USE, DATA, OR PROFITS; OR BUSINESS INTERRUPTION) HOWEVER CAUSED AND ON ANY THEORY OF LIABILITY, WHETHER IN CONTRACT, STRICT LIABILITY, OR TORT (INCLUDING NEGLIGENCE OR OTHERWISE) ARISING IN ANY WAY OUT OF THE USE OF THIS SOFTWARE, EVEN IF ADVISED OF THE POSSIBILITY OF SUCH DAMAGE.

**Net-SNMP**

Various copyrights apply to this package, listed in various separate parts below. Please make sure that you read all the parts.

---- Part 1: CMU/UCD copyright notice: (BSD like) ----

Copyright 1989, 1991, 1992 by Carnegie Mellon University

Derivative Work - 1996, 1998-2000  
Copyright 1996, 1998-2000 The Regents of the University of California

All Rights Reserved

Permission to use, copy, modify and distribute this software and its documentation for any purpose and without fee is hereby granted, provided that the above copyright notice appears in all copies and that both that copyright notice and this permission notice appear in supporting documentation, and that the name of CMU and The Regents of the University of California not be used in advertising or publicity pertaining to distribution of the software without specific written permission.

CMU AND THE REGENTS OF THE UNIVERSITY OF CALIFORNIA DISCLAIM ALL WARRANTIES WITH REGARD TO THIS SOFTWARE, INCLUDING ALL IMPLIED WARRANTIES OF MERCHANTABILITY AND FITNESS. IN NO EVENT SHALL CMU OR THE REGENTS OF THE UNIVERSITY OF CALIFORNIA BE LIABLE FOR ANY SPECIAL, INDIRECT OR CONSEQUENTIAL DAMAGES OR ANY DAMAGES WHATSOEVER RESULTING FROM THE LOSS OF USE, DATA OR PROFITS, WHETHER IN AN ACTION OF CONTRACT, NEGLIGENCE OR OTHER TORTIOUS ACTION, ARISING OUT OF OR IN CONNECTION WITH THE USE OR PERFORMANCE OF THIS SOFTWARE.

---- Part 2: Networks Associates Technology, Inc copyright notice (BSD) ----

Copyright (c) 2001-2003, Networks Associates Technology, Inc  
All rights reserved.

Redistribution and use in source and binary forms, with or without modification, are permitted provided that the following conditions are met:

- \* Redistributions of source code must retain the above copyright notice, this list of conditions and the following disclaimer.
- \* Redistributions in binary form must reproduce the above copyright notice, this list of conditions and the following disclaimer in the documentation and/or other materials provided with the distribution.
- \* Neither the name of the Networks Associates Technology, Inc nor the names of its contributors may be used to endorse or promote products derived from this software without specific prior written permission.

THIS SOFTWARE IS PROVIDED BY THE COPYRIGHT HOLDERS AND CONTRIBUTORS "AS IS" AND ANY EXPRESS OR IMPLIED WARRANTIES, INCLUDING, BUT NOT LIMITED TO, THE IMPLIED WARRANTIES OF MERCHANTABILITY AND FITNESS FOR A PARTICULAR PURPOSE ARE DISCLAIMED. IN NO EVENT SHALL THE COPYRIGHT HOLDERS OR CONTRIBUTORS BE LIABLE FOR ANY DIRECT, INDIRECT, INCIDENTAL, SPECIAL, EXEMPLARY, OR CONSEQUENTIAL DAMAGES (INCLUDING, BUT NOT LIMITED TO, PROCUREMENT OF SUBSTITUTE GOODS OR SERVICES; LOSS OF USE, DATA, OR PROFITS; OR BUSINESS INTERRUPTION) HOWEVER CAUSED AND ON ANY THEORY OF LIABILITY, WHETHER IN CONTRACT, STRICT LIABILITY, OR TORT (INCLUDING NEGLIGENCE OR OTHERWISE) ARISING IN ANY WAY OUT OF THE USE OF THIS SOFTWARE, EVEN IF ADVISED OF THE POSSIBILITY OF SUCH DAMAGE.

---- Part 3: Cambridge Broadband Ltd. copyright notice (BSD) ----

Portions of this code are copyright (c) 2001-2003, Cambridge Broadband Ltd.  
All rights reserved.

Redistribution and use in source and binary forms, with or without modification, are permitted provided that the following conditions are met:

- \* Redistributions of source code must retain the above copyright notice, this list of conditions and the following disclaimer.
- \* Redistributions in binary form must reproduce the above copyright notice, this list of conditions and the following disclaimer in the documentation and/or other materials provided with the distribution.
- \* The name of Cambridge Broadband Ltd. may not be used to endorse or promote products derived from this software without specific prior written permission.

THIS SOFTWARE IS PROVIDED BY THE COPYRIGHT HOLDER "AS IS" AND ANY EXPRESS OR IMPLIED WARRANTIES, INCLUDING, BUT NOT LIMITED TO, THE IMPLIED WARRANTIES OF MERCHANTABILITY AND FITNESS FOR A PARTICULAR PURPOSE ARE DISCLAIMED. IN NO EVENT SHALL THE COPYRIGHT HOLDER BE LIABLE FOR ANY DIRECT, INDIRECT, INCIDENTAL, SPECIAL, EXEMPLARY, OR CONSEQUENTIAL DAMAGES (INCLUDING, BUT NOT LIMITED TO, PROCUREMENT OF SUBSTITUTE GOODS OR SERVICES; LOSS OF USE, DATA, OR PROFITS; OR BUSINESS INTERRUPTION) HOWEVER CAUSED AND ON ANY THEORY OF LIABILITY, WHETHER IN CONTRACT, STRICT LIABILITY, OR TORT (INCLUDING NEGLIGENCE OR OTHERWISE) ARISING IN ANY WAY OUT OF THE USE OF THIS SOFTWARE, EVEN IF ADVISED OF THE POSSIBILITY OF SUCH DAMAGE.

---- Part 4: Sun Microsystems, Inc. copyright notice (BSD) ----

Copyright (c) 2003 Sun Microsystems, Inc., 4150 Network Circle, Santa Clara, California 95054, U.S.A. All rights reserved.

Use is subject to license terms below.

This distribution may include materials developed by third parties.

Sun, Sun Microsystems, the Sun logo and Solaris are trademarks or registered trademarks of Sun Microsystems, Inc. in the U.S. and other countries.

Redistribution and use in source and binary forms, with or without modification, are permitted provided that the following conditions are met:

- \* Redistributions of source code must retain the above copyright notice, this list of conditions and the following disclaimer.
- \* Redistributions in binary form must reproduce the above copyright notice, this list of conditions and the following disclaimer in the documentation and/or other materials provided with the distribution.
- \* Neither the name of the Sun Microsystems, Inc. nor the names of its contributors may be used to endorse or promote products derived from this software without specific prior written permission.

THIS SOFTWARE IS PROVIDED BY THE COPYRIGHT HOLDERS AND CONTRIBUTORS "AS IS" AND ANY EXPRESS OR IMPLIED WARRANTIES, INCLUDING, BUT NOT LIMITED TO, THE IMPLIED WARRANTIES OF MERCHANTABILITY AND FITNESS FOR A PARTICULAR PURPOSE ARE DISCLAIMED. IN NO EVENT SHALL THE COPYRIGHT HOLDERS OR CONTRIBUTORS BE LIABLE FOR ANY DIRECT, INDIRECT, INCIDENTAL, SPECIAL, EXEMPLARY, OR CONSEQUENTIAL DAMAGES (INCLUDING, BUT NOT LIMITED TO, PROCUREMENT OF SUBSTITUTE GOODS OR SERVICES; LOSS OF USE, DATA, OR PROFITS; OR BUSINESS INTERRUPTION) HOWEVER CAUSED AND ON ANY THEORY OF LIABILITY, WHETHER IN CONTRACT, STRICT LIABILITY, OR TORT (INCLUDING NEGLIGENCE OR OTHERWISE) ARISING IN ANY WAY OUT OF THE USE OF THIS SOFTWARE, EVEN IF ADVISED OF THE POSSIBILITY OF SUCH DAMAGE.

---- Part 5: Sparta, Inc copyright notice (BSD) ----

Copyright (c) 2003-2012, Sparta, Inc  
All rights reserved.

Redistribution and use in source and binary forms, with or without modification, are permitted provided that the following conditions are met:

- \* Redistributions of source code must retain the above copyright notice, this list of conditions and the following disclaimer.
- \* Redistributions in binary form must reproduce the above copyright notice, this list of conditions and the following disclaimer in the documentation and/or other materials provided with the distribution.



\* Neither the name of Sparta, Inc nor the names of its contributors may be used to endorse or promote products derived from this software without specific prior written permission.

THIS SOFTWARE IS PROVIDED BY THE COPYRIGHT HOLDERS AND CONTRIBUTORS "AS IS" AND ANY EXPRESS OR IMPLIED WARRANTIES, INCLUDING, BUT NOT LIMITED TO, THE IMPLIED WARRANTIES OF MERCHANTABILITY AND FITNESS FOR A PARTICULAR PURPOSE ARE DISCLAIMED. IN NO EVENT SHALL THE COPYRIGHT HOLDERS OR CONTRIBUTORS BE LIABLE FOR ANY DIRECT, INDIRECT, INCIDENTAL, SPECIAL, EXEMPLARY, OR CONSEQUENTIAL DAMAGES (INCLUDING, BUT NOT LIMITED TO, PROCUREMENT OF SUBSTITUTE GOODS OR SERVICES; LOSS OF USE, DATA, OR PROFITS; OR BUSINESS INTERRUPTION) HOWEVER CAUSED AND ON ANY THEORY OF LIABILITY, WHETHER IN CONTRACT, STRICT LIABILITY, OR TORT (INCLUDING NEGLIGENCE OR OTHERWISE) ARISING IN ANY WAY OUT OF THE USE OF THIS SOFTWARE, EVEN IF ADVISED OF THE POSSIBILITY OF SUCH DAMAGE.

---- Part 6: Cisco/BUPTNIC copyright notice (BSD) ----

Copyright (c) 2004, Cisco, Inc and Information Network Center of Beijing University of Posts and Telecommunications.  
All rights reserved.

Redistribution and use in source and binary forms, with or without modification, are permitted provided that the following conditions are met:

- \* Redistributions of source code must retain the above copyright notice, this list of conditions and the following disclaimer.
- \* Redistributions in binary form must reproduce the above copyright notice, this list of conditions and the following disclaimer in the documentation and/or other materials provided with the distribution.
- \* Neither the name of Cisco, Inc, Beijing University of Posts and Telecommunications, nor the names of their contributors may be used to endorse or promote products derived from this software without specific prior written permission.

THIS SOFTWARE IS PROVIDED BY THE COPYRIGHT HOLDERS AND CONTRIBUTORS "AS IS" AND ANY EXPRESS OR IMPLIED WARRANTIES, INCLUDING, BUT NOT LIMITED TO, THE IMPLIED WARRANTIES OF MERCHANTABILITY AND FITNESS FOR A PARTICULAR PURPOSE ARE DISCLAIMED. IN NO EVENT SHALL THE COPYRIGHT HOLDERS OR CONTRIBUTORS BE LIABLE FOR ANY DIRECT, INDIRECT, INCIDENTAL, SPECIAL, EXEMPLARY, OR CONSEQUENTIAL DAMAGES (INCLUDING, BUT NOT LIMITED TO, PROCUREMENT OF SUBSTITUTE GOODS OR SERVICES; LOSS OF USE, DATA, OR PROFITS; OR BUSINESS INTERRUPTION) HOWEVER CAUSED AND ON ANY THEORY OF LIABILITY, WHETHER IN CONTRACT, STRICT LIABILITY, OR TORT (INCLUDING NEGLIGENCE OR OTHERWISE) ARISING IN ANY WAY OUT OF THE USE OF THIS SOFTWARE, EVEN IF ADVISED OF THE POSSIBILITY OF SUCH DAMAGE.

---- Part 7: Fabasoft R&D Software GmbH & Co KG copyright notice (BSD) ----

Copyright (c) Fabasoft R&D Software GmbH & Co KG, 2003 oss@fabasoft.com  
Author: Bernhard Penz <bernhard.penz@fabasoft.com>

Redistribution and use in source and binary forms, with or without modification, are permitted provided that the following conditions are met:

- \* Redistributions of source code must retain the above copyright notice, this list of conditions and the following disclaimer.
- \* Redistributions in binary form must reproduce the above copyright notice, this list of conditions and the following disclaimer in the documentation and/or other materials provided with the distribution.
- \* The name of Fabasoft R&D Software GmbH & Co KG or any of its subsidiaries, brand or product names may not be used to endorse or promote products derived from this software without specific prior written permission.

THIS SOFTWARE IS PROVIDED BY THE COPYRIGHT HOLDER "AS IS" AND ANY EXPRESS OR IMPLIED WARRANTIES, INCLUDING, BUT NOT LIMITED TO, THE IMPLIED WARRANTIES OF MERCHANTABILITY AND FITNESS FOR A PARTICULAR PURPOSE ARE DISCLAIMED. IN NO EVENT SHALL THE COPYRIGHT HOLDER BE LIABLE FOR ANY DIRECT, INDIRECT, INCIDENTAL, SPECIAL, EXEMPLARY, OR CONSEQUENTIAL DAMAGES (INCLUDING, BUT NOT LIMITED TO, PROCUREMENT OF SUBSTITUTE GOODS OR SERVICES; LOSS OF USE, DATA, OR PROFITS; OR BUSINESS INTERRUPTION) HOWEVER CAUSED AND ON ANY THEORY OF LIABILITY, WHETHER IN CONTRACT, STRICT LIABILITY, OR TORT (INCLUDING NEGLIGENCE OR OTHERWISE) ARISING IN ANY WAY OUT OF THE USE OF THIS SOFTWARE, EVEN IF ADVISED OF THE POSSIBILITY OF SUCH DAMAGE.

---- Part 8: Apple Inc. copyright notice (BSD) ----

Copyright (c) 2007 Apple Inc. All rights reserved.

Redistribution and use in source and binary forms, with or without modification, are permitted provided that the following conditions are met:

1. Redistributions of source code must retain the above copyright notice, this list of conditions and the following disclaimer.
2. Redistributions in binary form must reproduce the above copyright notice, this list of conditions and the following disclaimer in the documentation and/or other materials provided with the distribution.
3. Neither the name of Apple Inc. ("Apple") nor the names of its contributors may be used to endorse or promote products derived from this software without specific prior written permission.

THIS SOFTWARE IS PROVIDED BY APPLE AND ITS CONTRIBUTORS "AS IS" AND ANY EXPRESS OR IMPLIED WARRANTIES, INCLUDING, BUT NOT LIMITED TO, THE IMPLIED WARRANTIES OF MERCHANTABILITY AND FITNESS FOR A PARTICULAR PURPOSE ARE DISCLAIMED. IN NO EVENT SHALL APPLE OR ITS CONTRIBUTORS BE LIABLE FOR ANY DIRECT, INDIRECT, INCIDENTAL, SPECIAL, EXEMPLARY, OR CONSEQUENTIAL DAMAGES (INCLUDING, BUT NOT LIMITED TO, PROCUREMENT OF SUBSTITUTE GOODS OR SERVICES; LOSS OF USE, DATA, OR PROFITS; OR BUSINESS INTERRUPTION) HOWEVER CAUSED AND ON ANY THEORY OF LIABILITY, WHETHER IN CONTRACT, STRICT LIABILITY, OR TORT (INCLUDING NEGLIGENCE OR OTHERWISE) ARISING IN ANY WAY OUT OF THE USE OF THIS SOFTWARE, EVEN IF ADVISED OF THE POSSIBILITY OF SUCH DAMAGE.

---- Part 9: ScienceLogic, LLC copyright notice (BSD) ----

Copyright (c) 2009, ScienceLogic, LLC  
All rights reserved.

Redistribution and use in source and binary forms, with or without modification, are permitted provided that the following conditions are met:

- \* Redistributions of source code must retain the above copyright notice, this list of conditions and the following disclaimer.
- \* Redistributions in binary form must reproduce the above copyright notice, this list of conditions and the following disclaimer in the documentation and/or other materials provided with the distribution.
- \* Neither the name of ScienceLogic, LLC nor the names of its contributors may be used to endorse or promote products derived from this software without specific prior written permission.

THIS SOFTWARE IS PROVIDED BY THE COPYRIGHT HOLDERS AND CONTRIBUTORS "AS IS" AND ANY EXPRESS OR IMPLIED WARRANTIES, INCLUDING, BUT NOT LIMITED TO, THE IMPLIED WARRANTIES OF MERCHANTABILITY AND FITNESS FOR A PARTICULAR PURPOSE ARE DISCLAIMED. IN NO EVENT SHALL THE COPYRIGHT HOLDERS OR CONTRIBUTORS BE LIABLE FOR ANY DIRECT, INDIRECT, INCIDENTAL, SPECIAL, EXEMPLARY, OR CONSEQUENTIAL DAMAGES (INCLUDING, BUT NOT LIMITED TO, PROCUREMENT OF SUBSTITUTE GOODS OR SERVICES; LOSS OF USE, DATA, OR PROFITS; OR BUSINESS INTERRUPTION) HOWEVER CAUSED AND ON ANY THEORY OF LIABILITY, WHETHER IN CONTRACT, STRICT LIABILITY, OR TORT (INCLUDING NEGLIGENCE OR OTHERWISE) ARISING IN ANY WAY OUT OF THE USE OF THIS SOFTWARE, EVEN IF ADVISED OF THE POSSIBILITY OF SUCH DAMAGE.

SNMP++

Copyright (c) 2001-2007 Jochen Katz, Frank Fock

This software is based on SNMP++2.6 from Hewlett Packard:

Copyright (c) 1996  
Hewlett-Packard Company

ATTENTION: USE OF THIS SOFTWARE IS SUBJECT TO THE FOLLOWING TERMS.

Permission to use, copy, modify, distribute and/or sell this software and/or its documentation is hereby granted without fee. User agrees to display the above copyright notice and this license notice in all copies of the software and any documentation of the software. User agrees to assume all liability for the use of the software; Hewlett-Packard and Jochen Katz make no representations about the suitability of this software for any purpose. It is provided "AS-IS" without warranty of any kind, either express or implied. User hereby grants a royalty-free license to any and all derivatives based upon this software code base.

Apache License

Copyright [2016] [Sharp Corporation]

Licensed under the Apache License, Version 2.0 (the "License"); you may not use this file except in compliance with the License.  
You may obtain a copy of the License at

<http://www.apache.org/licenses/LICENSE-2.0>

Unless required by applicable law or agreed to in writing, software distributed under the License is distributed on an "AS IS" BASIS, WITHOUT WARRANTIES OR CONDITIONS OF ANY KIND, either express or implied.  
See the License for the specific language governing permissions and limitations under the License.

SIL Open Font License

"Noto Sans CJK JP Regular" and "Noto Sans CJK JP Bold"  
licensed under the SIL Open Font License <http://www.google.com/get/noto/#/>

**SHARP**<sup>®</sup>  
SHARP CORPORATION