

# SHARP®

MODEL: MX-B402  
MX-B402SC

DIGITAL MULTIFUNCTIONAL SYSTEM

# START GUIDE



Keep this manual close at hand for reference whenever needed.

Each instruction also covers the optional units used with these products.

**Caution!**

For complete electrical disconnection, pull out the main plug.  
The socket-outlet shall be installed near the equipment and shall be easily accessible.  
To reduce the risk of fire, use only UL-Listed No. 26 AWG or larger telecommunication line cord.

**FAX interface cable and Line cable:**

These special accessories must be used with the device.

**FOR YOUR RECORDS ...**

To protect against loss or theft, record and retain for reference the machine's serial number located at the lower left corner of the left side of the machine.

Model Number \_\_\_\_\_

Serial Number \_\_\_\_\_

Date of Purchase \_\_\_\_\_

Place of Purchase \_\_\_\_\_

Authorized Sharp Printer \_\_\_\_\_

Service Department Number \_\_\_\_\_

**Notice for Users in U.S.A.:**

**EMC (this machine and peripheral devices)**

**WARNING:**

FCC Regulations state that any unauthorized changes or modifications to this equipment not expressly approved by the manufacturer could void the user's authority to operate this equipment.

Shielded interface cables must be used with this equipment to maintain compliance with EMC regulations.

**NOTE:**

This equipment has been tested and found to comply with the limits for a Class A digital device, pursuant to Part 15 of the FCC Rules. These limits are designed to provide reasonable protection against harmful interference when the equipment is operated in a commercial environment. This equipment generates, uses, and can radiate radio frequency energy and, if not installed and used in accordance with the instruction manual, may cause harmful interference to radio communications. Operation of this equipment in a residential area is likely to cause harmful interference in which case the user will be required to correct the interference at his own expense.

This machine contains the software having modules developed by Independent JPEG Group.

This product includes Adobe® Flash® technology of Adobe Systems Incorporated.  
Copyright© 1995-2007 Adobe Macromedia Software LLC. All rights reserved.

# Contents

<b>CAUTIONS</b> . . . . .	<b>3</b>	<b>SETUP IN A WINDOWS ENVIRONMENT</b> . . . . .	<b>29</b>
Symbols in this manual . . . . .	3	OPENING THE SOFTWARE SELECTION SCREEN (FOR ALL SOFTWARE) . . . . .	29
Power notes . . . . .	3	INSTALLING THE PRINTER DRIVER / PC-FAX DRIVER . . . . .	31
Installation notes . . . . .	4	<b>REGULAR MAINTENANCE</b> . . . . .	<b>37</b>
About consumables . . . . .	5	<b>SUPPLIES</b> . . . . .	<b>38</b>
Handling precautions . . . . .	6	<b>SPECIFICATIONS</b> . . . . .	<b>39</b>
Laser information . . . . .	8	Machine specifications / copier specifications . . . . .	39
<b>OPERATION MANUALS AND HOW TO USE THEM</b> . . . . .	<b>9</b>	Continuous copying speeds* . . . . .	42
<b>DIGITAL MULTIFUNCTIONAL SYSTEM FUNCTIONS</b> . . . . .	<b>10</b>	Ambient environment . . . . .	42
<b>ACCESSING THE WEB SERVER IN THE MACHINE</b> . . . . .	<b>11</b>	Chemical emission (measured according to RAL-UZ122: Edition Jun. 2006) . . . . .	43
Opening the Web pages . . . . .	11	Acoustic noise emission (measurement according to ISO7779) . . . . .	43
<b>CHECKING THE IP ADDRESS</b> . . . . .	<b>12</b>	Automatic document feeder specifications . . . . .	44
<b>PART NAMES AND FUNCTIONS</b> . . . . .	<b>13</b>	<b>TO THE ADMINISTRATOR OF THE MACHINE</b> . . . . .	<b>46</b>
<b>SUPPLIES</b> . . . . .	<b>14</b>	Factory default passwords . . . . .	46
<b>OPERATION PANEL</b> . . . . .	<b>15</b>	Forwarding all transmitted and received data to the administrator (document administration function) . . . . .	46
<b>TURNING THE POWER ON AND OFF</b> . . . . .	<b>17</b>	For the users of the fax function . . . . .	47
<b>PLACING ORIGINALS</b> . . . . .	<b>18</b>	Trademark acknowledgments . . . . .	51
Using the automatic document feeder . . . . .	18		
Using the document glass . . . . .	19		
<b>CHANGING PAPER IN A TRAY</b> . . . . .	<b>20</b>		
Names of the trays . . . . .	20		
Loading paper in a tray . . . . .	21		
Loading paper in bypass tray . . . . .	22		
<b>BEFORE INSTALLING THE SOFTWARE</b> . . . . .	<b>23</b>		
CD-ROMS AND SOFTWARE . . . . .	23		
VERIFYING SYSTEM REQUIREMENTS . . . . .	26		
CONNECTING THE MACHINE . . . . .	28		

**Note:**

- The explanations in this manual assume that 500 sheet paper feed units (total of four trays) are installed on the MX-B402.
- Considerable care has been taken in preparing this manual. If you have any comments or concerns about the manual, please contact your dealer or nearest SHARP Service Department.
- This product has undergone strict quality control and inspection procedures. In the unlikely event that a defect or other problem is discovered, please contact your dealer or nearest SHARP Service Department.
- Aside from instances provided for by law, SHARP is not responsible for failures occurring during the use of the product or its options, or failures due to incorrect operation of the product and its options, or other failures, or for any damage that occurs due to use of the product.



Products that have earned the ENERGY STAR® are designed to protect the environment through superior energy efficiency.

**Warranty**



While every effort has been made to make this document as accurate and helpful as possible, SHARP Corporation makes no warranty of any kind with regard to its content. All information included herein is subject to change without notice. SHARP is not responsible for any loss or damages, direct or indirect, arising from or related to the use of this operation manual.

©Copyright SHARP Corporation 2010. All rights reserved. Reproduction, adaptation or translation without prior written permission is prohibited, except as allowed under copyright laws.





# CAUTIONS

## Symbols in this manual

To ensure safe use of the machine, this manual uses various safety symbols. The safety symbols are classified as explained below. Be sure you understand the meaning of the symbols when reading the manual.

Symbol	Meaning
 <b>WARNING</b>	Indicates a risk of death or serious injury.
 <b>CAUTION</b>	Indicates a risk of human injury or property damage.

### Meaning of the symbols

Symbol	Meaning	Symbol	Meaning	Symbol	Meaning
	CAUTION! HOT		PROHIBITED ACTIONS		MANDATORY ACTIONS
	PINCH POINT KEEP CLEAR		DO NOT DISASSEMBLE		

## Power notes

### WARNING



Be sure to connect the power cord only to a power outlet that meets the specified voltage and current requirements. Also make certain the outlet is properly grounded. Do not use an extension cord or adapter to connect other devices to the power outlet used by the machine. Using an improper power supply may cause fire or electrical shock.

\*For the power supply requirements, see the name plate in the lower left corner of the left side of the machine.



Do not damage or modify the power cord.



Placing heavy objects on the power cord, pulling it, or forcibly bending it will damage the cord, resulting in fire or electrical shock.



Do not insert or remove the power plug with wet hands.

This may cause electrical shock.

### CAUTION



When removing the power plug from the outlet, do not pull on the cord.

Pulling on the cord may cause damage such as wire exposure and breakage, and may result in fire or electrical shock.



When moving the machine, switch off the main power and remove the power plug from the outlet before moving.

The cord may be damaged, creating a risk of fire or electrical shock.



If you will not use the machine for a long time, be sure to remove the power plug from the outlet for safety.

# Installation notes

## ⚠ CAUTION



**Do not install the machine on an unstable or slanted surface. Install the machine on a surface that can withstand the weight of the machine.**

Risk of injury due to the machine falling or toppling. If peripheral devices are to be installed, do not install on an uneven floor, slanted surface, or otherwise unstable surface. Danger of slippage, falling, and toppling. Install the product on a flat, stable surface that can withstand the weight of the product. (Weight when various peripheral devices are installed: approx. 125.7 lbs. (57 kg))



**Locations exposed to direct sunlight**

Plastic parts may become deformed and dirty output may result.

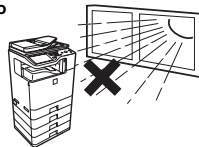

**Do not install in a location with moisture or dust.**



Risk of fire and electrical shock. If dust enters the machine, dirty output and machine failure may result.



**Locations with ammonia gas**



Installing the machine next to a diazo copy machine may cause dirty output.



**Locations that are excessively hot, cold, humid, or dry (near heaters, humidifiers, air conditioners, etc.)**



The paper will become damp and condensation may form inside the machine, causing misfeeds and dirty output.

☞ Ambient environment (page 42)

If the location has an ultrasonic humidifier, use pure water for humidifiers in the humidifier. If tap water is used, minerals and other impurities will be emitted, causing impurities to collect on the inside of the machine and create dirty output.



**Do not install the machine in a location with poor ventilation. Install so that exhaust from the machine does not directly contact people.**

A small amount of ozone is created inside the machine during printing. The amount of ozone created is not sufficient to be harmful; however, an unpleasant odor may be noticed during large copy runs, and thus the machine should be installed in a room with a ventilation fan or windows that provide sufficient air circulation. (The odor may occasionally cause headaches.)

\* Install the machine so that people are not directly exposed to exhaust from the machine. If installed near a window, ensure that the machine is not exposed to direct sunlight.

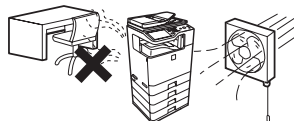

## Installation notes (continued)

### ⚠ CAUTION



#### Near a wall

Be sure to allow the required space around the machine for servicing and proper ventilation. (The machine should be no closer than the distances indicated below from walls. The indicated distances are for the case when a saddle finisher and large capacity paper tray are not installed.)

MX-B402:

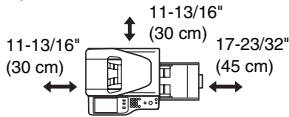

MX-B402SC:

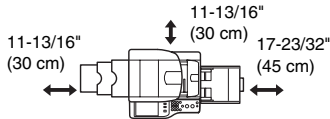

#### Locations subject to vibration.

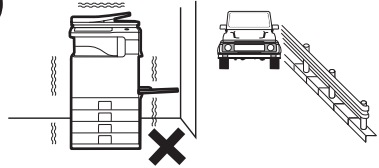

Vibration may cause failure.



**The machine includes a built-in hard drive. Do not subject the machine to shock or vibration. In particular, never move the machine while the power is on.**

- The machine should be installed near an accessible power outlet for easy connection.
- Connect the machine to a power outlet which is not used for other electric appliances. If a lighting fixture is connected to the same outlet, the light may flicker.

## About consumables

### ⚠ CAUTION



**Do not throw a toner cartridge into a fire.**  
Toner may fly and cause burns.



**Store a toner cartridge out of the reach of children.**

# Handling precautions

## ! WARNING



**Do not place a container of water or other liquid, or a metal object that might fall inside, on the machine.**



If the liquid spills or the object falls into the machine, fire or electrical shock may result.



**If you notice smoke, a strange odor, or other abnormality, do not use the machine.**



If used in this condition, fire or electrical shock may result. Immediately switch off the main power and remove the power plug from the power outlet. Contact your dealer or nearest SHARP Service Department.



**Do not remove the machine casing.**

High-voltage parts inside the machine may cause electrical shock.



**Do not make any modifications to this machine.**

Doing so may result in personal injury or damage to the machine.



**Do not use a flammable spray to clean the machine.**

If gas from the spray comes in contact with hot electrical components or the fusing unit inside the machine, fire or electrical shock may result.



**If a thunder storm begins, switch off the main power and remove the power plug from the outlet to prevent electrical shock and fire due to lightning.**



**If a piece of metal or water enters the machine, switch off the main power and remove the power plug from the power outlet.**

Contact your dealer or nearest SHARP Service Department. Using the machine in this condition may result in electrical shock or fire.

## ! CAUTION



**Do not look directly at the light source.**



Doing so may damage your eyes.



**The fusing unit and paper exit area are hot. When removing a misfeed, do not touch the fusing unit and paper exit area. Take care not to burn yourself.**

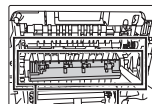

Fusing unit Paper exit area



**Do not block the ventilation ports on the machine. Do not install the machine in a location that will block the ventilation ports.**

Blocking the ventilation ports will cause heat to build up in the machine, creating a risk of fire.



**When loading paper, removing a misfeed, performing maintenance, closing the front and side covers, and inserting and removing trays, take care that your fingers are not pinched.**

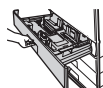



The machine includes the document filing function, which stores document image data on the machine's hard drive. Stored documents can be called up and printed or transmitted as needed. If a hard drive failure occurs, it will no longer be possible to call up the stored document data. To prevent the loss of important documents in the unlikely event of a hard drive failure, keep the originals of important documents or store the original data elsewhere.

With the exception of instances provided for by law, Sharp Corporation bears no responsibility for any damages or loss due to the loss of stored document data.

### "BATTERY DISPOSAL "

THIS PRODUCT CONTAINS A LITHIUM PRIMARY MEMORY BACK-UP BATTERY THAT MUST BE DISPOSED OF PROPERLY. PLEASE CONTACT YOUR LOCAL SHARP DEALER OR AUTHORIZED SERVICE REPRESENTATIVE FOR ASSISTANCE IN DISPOSING OF THIS BATTERY.

This product utilizes a CR coin lithium battery which contains a Perchlorate material. Special handling for this material may apply, California residents, see [www.dtsc.ca.gov/hazardouswaste/perchlorate/](http://www.dtsc.ca.gov/hazardouswaste/perchlorate/)  
Others, consult local environmental officers.

This product utilizes tin-lead solder, and a fluorescent lamp containing a small amount of mercury. Disposal of these materials may be regulated due to environmental consideration. For disposal or recycling information, please contact your local authorities, the Electronics Industries Alliance: [www.eiae.org](http://www.eiae.org), the lamp recycling organization: [www.lamprecycle.org](http://www.lamprecycle.org) or Sharp at 1-800-BE-SHARP.  
(For U.S.A. Only)

### For North America

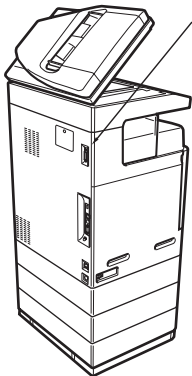

Inner Finisher Interface

Do not connect to devices other than specified peripheral devices of our company.

## CAUTIONS

---

### Laser information

Wave length	790 nm $\pm$ 10 nm
Pulse times (North America and Europe)	4.1 $\mu$ s $\pm$ 4.1 ns /7 mm
Output power	Max 0.6 mW (LD1+ LD2)

#### Caution

Use of controls or adjustments or performance of procedures other than those specified herein may result in hazardous radiation exposure.

This Digital Equipment is CLASS 1 LASER PRODUCT (IEC 60825-1 Edition 1.2-2001)

#### SAFETY PRECAUTIONS

This Digital Equipment is rated Class 1 and complies with 21 CFR 1040.10 and 1040.11 of the CDRH standards. This means that the equipment does not produce hazardous laser radiation. For your safety, observe the precautions below.

- Do not remove the cabinet, operation panel or any other covers.
- The equipment's exterior covers contain several safety interlock switches. Do not bypass any safety interlock by inserting wedges or other items into switch slots.

# OPERATION MANUALS AND HOW TO USE THEM

Printed manuals and a manual in PDF format are provided with the machine.

## Printed manuals

This section explains precautions to ensure safe usage, part names and functions and basic software. Refer to the PDF instruction manual for instructions on how to use the machine.

### Start Guide (this manual)

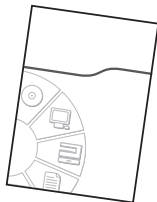

## Manuals in PDF format

The explanation of the functions that can be used on the machine are provided in the Operation Guide in PDF format. The Operation Guide can be downloaded from the Web pages in the machine.

### Operation Guide

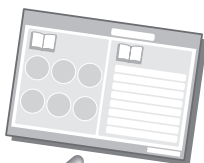

Download the Operation Guide from the Web pages in the machine.

Name	Desc
<input checked="" type="radio"/> Operation Guide	Operat

Download(O)



#### Convenient methods for using the Operation Guide

The first page contains a regular table of contents as well as an "I want to..." table of contents. "I want to..." lets you jump to an explanation based on what you want to do. For example, "I use the copier function often, so I'd like to save paper". Use either table of contents as appropriate based on what you want to know.

The contents of the Operation Guide are as follows:

- BEFORE USING THE MACHINE
- FACSIMILE
- SYSTEM SETTINGS
- COPIER
- SCANNER / INTERNET FAX
- TROUBLESHOOTING
- PRINTER
- DOCUMENT FILING

\* To view the Operation Guide in PDF format, Adobe® Reader® or Acrobat® Reader® of Adobe Systems Incorporated is required. Adobe® Reader® can be downloaded from the following URL:  
<http://www.adobe.com/>

---

---

# DIGITAL MULTIFUNCTIONAL SYSTEM FUNCTIONS

This machine provides four major areas of functionality.  
Refer to the Operation Guide for details on using the various functions within each area.

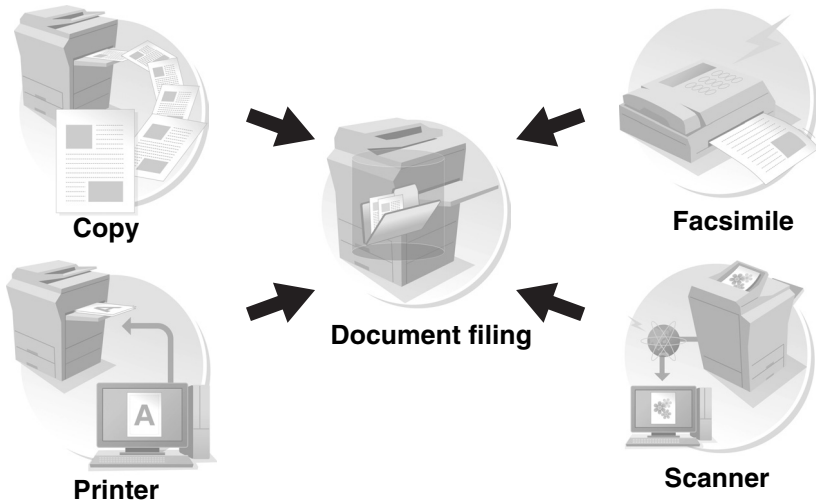

---

---

# ACCESSING THE WEB SERVER IN THE MACHINE

When the machine is connected to a network, the machine's built-in Web server can be accessed from a Web browser on your computer.

## Opening the Web pages

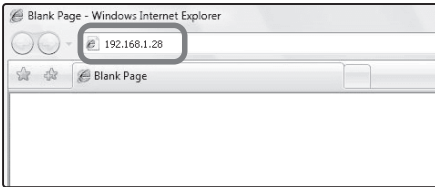

**Access the Web server in the machine to open the Web pages.**

**Start a Web browser on a computer that is connected to the same network as the machine and enter the IP address of the machine.**

Recommended Web browsers

- Internet Explorer: 6.0 or higher (Windows®)
- Netscape Navigator: 9 (Windows®)
- Firefox: 2.0 or higher (Windows®)
- Safari: 1.5 or higher (Macintosh)

The Web page will appear.

The machine settings may require that user authentication be performed in order to open the Web page. Please ask the administrator of the machine for the password that is required for user authentication.

# CHECKING THE IP ADDRESS

To check the IP address of the machine, print out the all custom setting list in the system settings.

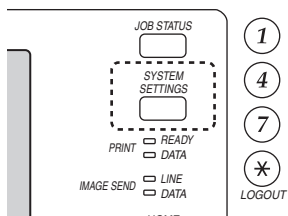

**1 Press the [SYSTEM SETTINGS] key.**

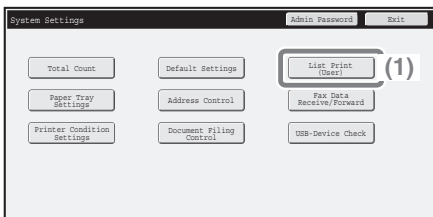

**2 Select the all custom setting list in the touch panel.**

**(1) Touch the [List Print (User)] key.**

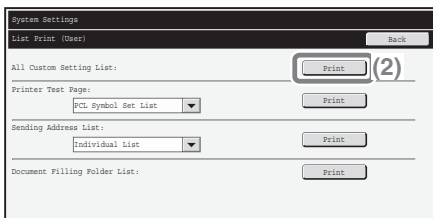

**(2) Touch the [Print] key to the right of "All Custom Setting List".**

The IP address is shown in the list that is printed.

# PART NAMES AND FUNCTIONS

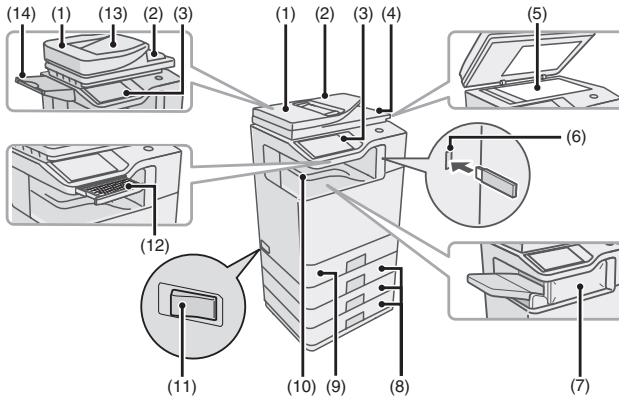

- (1) Automatic document feeder**  
This automatically feeds and scans multiple originals. Both sides of 2-sided originals can be scanned at once.
- (2) Document feeder tray**  
Place the originals in this tray when using the automatic document feeder.
- (3) Operation panel**
- (4) Original exit tray**  
Originals are delivered to this tray after scanning.
- (5) Document glass**  
This is used to scan books and other originals that cannot be scanned using the automatic document feeder.
- (6) USB connector (type A)**  
Supports USB 2.0 (Hi-Speed). This is used to connect a USB memory or other USB device to the machine.
- (7) Finisher\***  
This can be used to staple output.
- (8) Tray 2/Tray 3/Tray 4 (500 sheet paper feed unit is installed)\***  
This holds paper. Up to 500 sheets (21 lbs. (80 g/m<sup>2</sup>)) of paper can be loaded.
- (9) Tray 1**  
Up to 500 sheets of paper (21 lbs. (80 g/m<sup>2</sup>)) can be loaded in each tray.
- (10) Output tray (center tray)**  
Copy jobs and print jobs are delivered to this tray. (When a finisher is installed, the output tray (center tray) cannot be used.)
- (11) Main power switch**  
This is used to power on the machine. When using the fax or Internet fax functions, keep this switch in the "on" position.
- (12) Keyboard (MX-B402SC only)**  
This is a keyboard that is incorporated into the machine. When not used, it can be stored under the operation.
- (13) Original exit tray 1**  
Originals are delivered to this tray after scanning.
- (14) Original exit tray 2**  
If originals are not delivered to original exit tray 1 after scanning, they are delivered to this tray.

## SUPPLIES

\* Peripheral device. For more information, see "PERIPHERAL DEVICES" in "Chapter 1 - BEFORE USING THE MACHINE" in the Operation Guide.

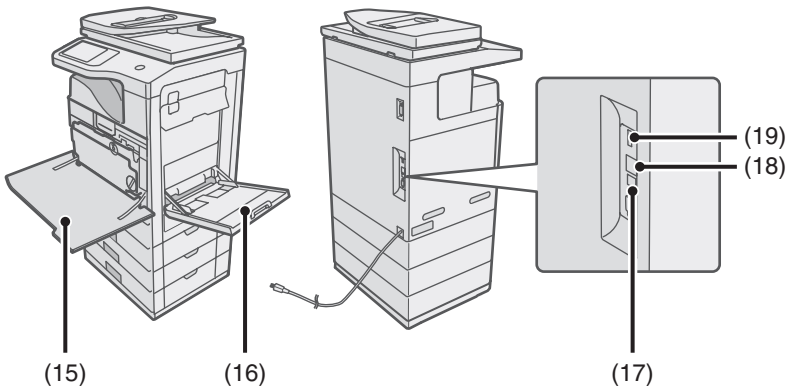

### (15) Front cover

Open to replace a toner cartridge.

### (16) Bypass tray

Special types of paper and envelopes can be fed from the bypass tray.

### (17) USB connector (B type)

Supports USB 2.0 (Hi-Speed).  
A computer can be connected to this connector to use the machine as a printer.

### (18) LAN connector

Connect the LAN cable to this connector when the machine is used on a network.

### (19) USB connector (type A)

This connector is the same as (6).  
On the MX-B402, this connector is set so that it cannot be used when shipped from the factory.  
To use this connector, please contact your service representative.

## SUPPLIES

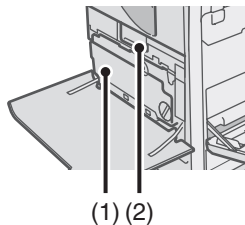

### (1) Toner collection container

This collects excess toner that remains after printing.

### (2) Toner cartridge

This contains toner for printing.  
When the toner runs out in a cartridge, the cartridge must be replaced.



# OPERATION PANEL

## Image send indicators

### LINE indicator

This lights up during transmission or reception in fax mode. The indicator also lights up during transmission in scan mode.

### DATA indicator

When a received fax cannot be printed because of a problem such as out of paper, the indicator blinks. The indicator lights steadily when there is data that is waiting to be transmitted.

## Touch panel

Messages and keys appear in the LCD display. Operations are performed by touching the keys with your finger.

## [JOB STATUS] key

Press this key to view the job status screen. You can check the status of jobs and cancel jobs in the job status screen.

## Print mode indicators

### READY indicator

Print data can be received when this indicator is lit.

### DATA indicator

This blinks while print data is being received and lights steadily while printing is taking place.

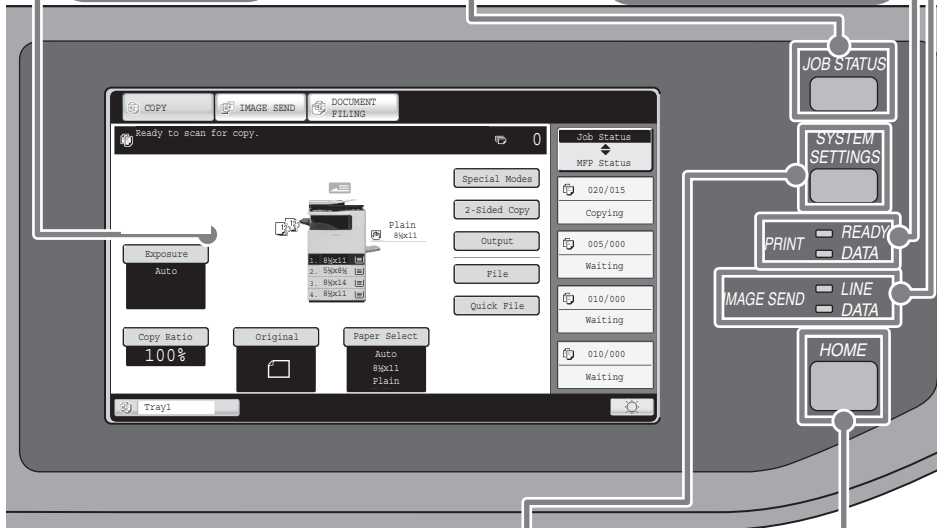

## [SYSTEM SETTINGS] key

Press this key to display the system settings screen. The system settings can be adjusted to make the machine easier to use, such as configuring paper tray settings and storing addresses.

## [HOME] key

Touch this key to display the home screen. The base screen of each mode is opened from the home screen.

### Numeric keys

These are used to enter the number of copies, fax numbers, and other numbers.

#### [LOGOUT] key ( \* )

When user authentication is enabled, press this key to log out after using the machine. When using the fax function, this key can be pressed to send tone signals on a pulse dial line.

#### [#/P] key ( #/P )

Press this key to use a job program when using the copier function. When using the fax function, this key can be used when dialing.

### [CLEAR] key

Press this key to return settings such as the number of copies to "0".

### Main power indicator

This indicator lights when the main power is switched on. The main power switch is on the left side of the machine.

### [POWER] key

Use this key to turn the machine power on and off.

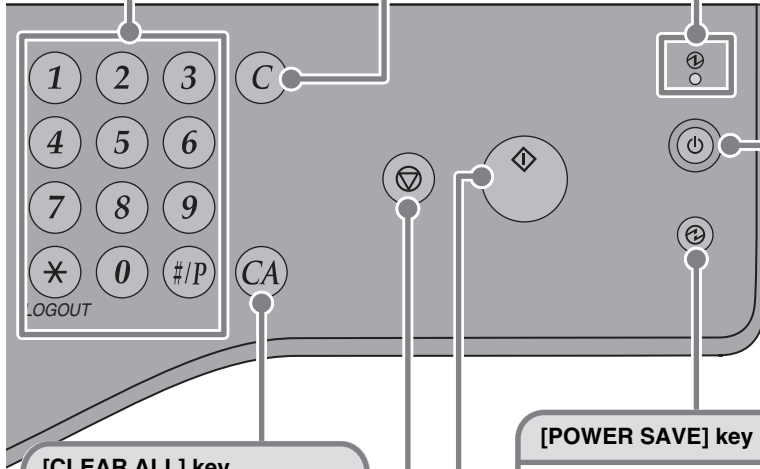

### [CLEAR ALL] key

Press this key to redo an operation from the beginning. All settings will be cleared and operation will return to the initial state.

### [STOP] key

Press this key to stop a copy job or scanning of an original.

### [POWER SAVE] key

Use this key to activate power save mode. The [POWER SAVE] key blinks when the machine is in power save mode. This key is also used to deactivate power save mode.

### [START] key

Use this key to copy or scan an original. This key is also used to send a fax in fax mode.

# TURNING THE POWER ON AND OFF

The machine has two power switches. One is the main power switch on the left side of the machine, and the other is the [POWER] key (⏻) on the upper right side of the operation panel.

## Main power switch

When the main power switch is switched on, the main power indicator on the operation panel lights up.

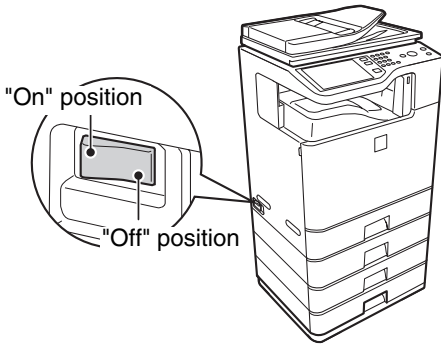

## [POWER] key

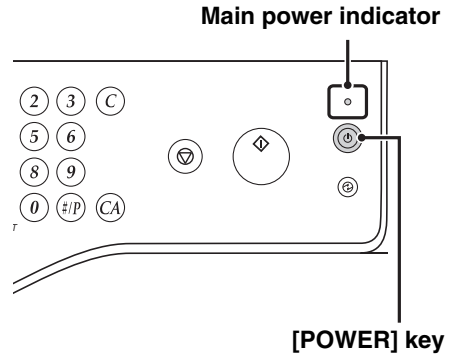

## Turning on the power

- (1) Switch the main power switch to the "on" position.
- (2) Press the [POWER] key (⏻) to turn on the power.

## Turning off the power

- (1) Press the [POWER] key (⏻) to turn off the power.
- (2) Switch the main power switch to the "off" position.

---

---

# PLACING ORIGINALS

The automatic document feeder can be used to automatically scan many originals at once. This saves you the trouble of manually feeding each original.

For originals that cannot be scanned using the automatic document feeder, such as a book or a document with notes attached, use the document glass.

## Using the automatic document feeder

When using the automatic document feeder, place the originals in the document feeder tray.

Make sure an original has not been placed on the document glass.

### When using the MX-B402

Set the original in the upper tray.

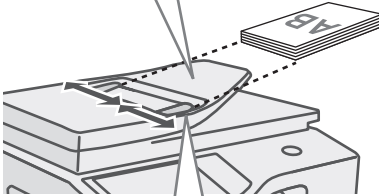

Place the originals face up with the edges aligned evenly.

▼ ▼ The indicator line indicates approximately how many originals can be placed. The placed originals must not be higher than this line.

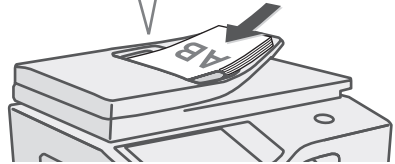

Adjust the original guides to the width of the originals.

### When using the MX-B402SC

Set the original in the lower tray.

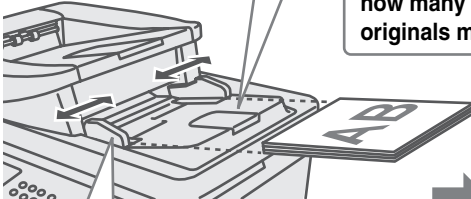

Place the originals face up with the edges aligned evenly.

▼ ▼ The indicator line indicates approximately how many originals can be placed. The placed originals must not be higher than this line.



Adjust the original guides to the width of the originals.

## Using the document glass

Take care that your fingers are not pinched when closing the automatic document feeder. After placing the original, be sure to close the automatic document feeder. If left open, parts outside of the original will be copied black, causing excessive use of toner.

**Place the original face down.**

**Align the middle of the original with the tip of the ► mark in the center of the glass.**



**Place the original face down.**

**To place a thick original such as a book, push up the far edge of the automatic document feeder and then close the automatic document feeder slowly. Do not press hard on the automatic document feeder. This may cause failure.**

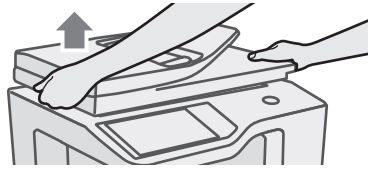

---

---

# CHANGING PAPER IN A TRAY

## Names of the trays

The names of the trays are shown below.

For the number of sheets of paper that can be loaded in each tray, see the following manuals:

- Operation Guide, "Paper Tray Settings" in "Chapter 7 - SYSTEM SETTINGS"
- Start Guide (this manual), "SPECIFICATIONS"

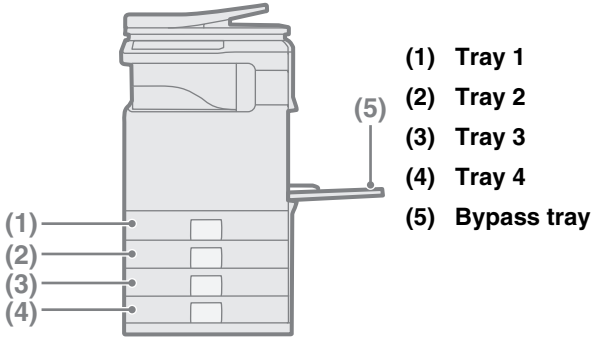

# Loading paper in a tray

A maximum of 500 sheets of paper from size 5-1/2" x 8-1/2" to size 8-1/2" x 14" (A5 to A4) can be loaded in trays 1 and 2.

A maximum of 500 sheets of paper from size 7-1/4" x 10-1/2" to size 8-1/2" x 14" (B5 to A4) can be loaded in trays 3 and 4.

**Gently pull out the paper tray. If paper remains in the tray, remove it.**

**Move the two guides on the tray. Load the paper so that it is not as shown below when viewed from the front and side of the machine.**

**The loaded paper should not go higher than these protrusions.**

**Insert the paper with the print side face up. Fan the paper well before inserting it.**

**Indicator line**  
The indicator line indicates the maximum height of the paper that can be loaded in the tray. When loading paper, make sure that the stack is not higher than the indicator line.

For detailed information, see "TRAY SETTINGS FOR TRAY 1 TO 4" in "Chapter 1 - BEFORE USING THE MACHINE" in the Operation Guide.

## Loading paper in bypass tray

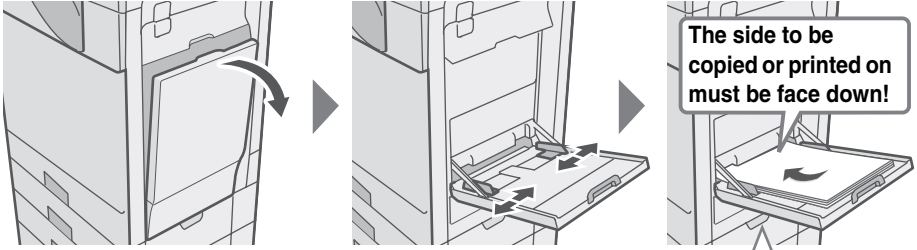

Load the paper in the horizontal orientation.

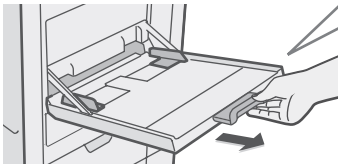

### Example: Loading an envelope

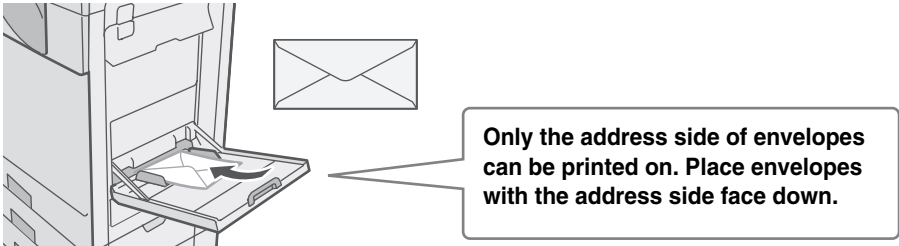

Do not place heavy objects on the bypass tray or press down on the tray. The bypass tray may be damaged, the machine may topple, and injury may result. Special types of paper that cannot be loaded in other trays can be loaded in the bypass tray.

For detailed information, see "LOADING PAPER IN THE BYPASS TRAY" in "Chapter 1 - BEFORE USING THE MACHINE" in the Operation Guide.



---

---

# BEFORE INSTALLING THE SOFTWARE

This chapter describes the software programs that allow you to use the printer and scanner functions of the machine, the CD-ROMs that contain the software, and the pages where the basic installation procedures can be found.

For details on installation procedures, refer to Chapter 1 of the Operation Guide.

## CD-ROMS AND SOFTWARE

The software that can be used with the machine is on the CD-ROMs that accompany the machine and the expansion kits.

Before installing the software, make sure that your computer and the machine meet the system requirements described in "VERIFYING SYSTEM REQUIREMENTS" (page 26).

### SOFTWARE CD-ROM

The "Software CD-ROM" that accompanies the machine contains the printer driver and other software. The "Software CD-ROM" consists of 2 discs.



- The CD-ROM does not include software for Mac OS 9.0 to 9.2.2/X10.2.8/X10.3.9.

Contact your dealer or nearest authorized service representative if you want software for Mac OS 9.0 to 9.2.2/X10.2.8/X10.3.9.

- The CD-ROM does not include printer driver for PCL5e. Contact your dealer or nearest authorized service representative if you want printer driver for PCL5e.

## Disc 1

### Software for Windows

#### • Printer driver

These allow the machine to be used as a printer.

##### - PCL6 printer driver

The machine supports the Hewlett-Packard PCL6 printer control languages.

##### - PS printer driver

The PS printer driver supports the PostScript 3 page description language developed by Adobe Systems Incorporated.

##### - PPD driver

The PPD driver enables the machine to use the standard Windows PS printer driver.

☞ WHEN THE MACHINE IS CONNECTED TO A NETWORK (page 31)

☞ WHEN THE MACHINE WILL BE CONNECTED WITH A USB CABLE  
(page 1-90 in the Operation Guide)

#### • Printer Status Monitor (can only be used when the machine is connected to a network)

This allows you to monitor the status of the machine on your computer screen.

☞ INSTALLING THE PRINTER STATUS MONITOR (page 1-100 in the Operation Guide)

### Software for Macintosh

#### • PPD file

This is the printer description file which enables the machine to be used as a PostScript 3 compatible printer.

☞ MAC OS X (page 1-107 in the Operation Guide)

☞ MAC OS 9.0 - 9.2.2 (page 1-113 in the Operation Guide)

- To use the machine as a printer in a Macintosh environment, the machine must be connected to a network. A USB connection cannot be used.
- The scanner driver and PC-Fax driver cannot be used in a Macintosh environment.

## Disc 2

### Software for Windows

- **PC-Fax driver**

This enables you to send a file from your computer as a fax using the same procedure as when printing the file. (When the fax option is installed.) Even if the fax function is not installed, the PC-Fax driver can be updated using the CD-ROM in the Internet fax expansion kit to enable you to send a file from your computer as an Internet fax in the same way as you print a file.

📖 INSTALLING THE PRINTER DRIVER / PC-FAX DRIVER (page 31)

- **Scanner driver (TWAIN driver)**

**(Can only be used when the machine is connected to a network.)**

This allows you to use the scanner function of the machine from a TWAIN-compliant software application.

📖 INSTALLING THE SCANNER DRIVER (page 1-101 in the Operation Guide)

### OTHER CD-ROMS

#### ▶ **"PRINTER UTILITIES" CD-ROM that accompanies the Internet fax expansion kit (for Windows)**

This CD-ROM is used to update the PC-Fax driver on the "Software CD-ROM" so that it can be used to send Internet faxes (PC-I-Fax function).

If you wish to use the PC-I-Fax function, first install the PC-Fax driver from the "Software CD-ROM" and then run the installer on this CD-ROM. If the PC-Fax driver is already installed, run only the installer. (There is no need to reinstall the PC-Fax driver.)

📖 INSTALLING THE PRINTER DRIVER / PC-FAX DRIVER (page 31)

#### ▶ **"Sharpdesk/Network Scanner Utilities" CD-ROM (for Windows)**

This contains software that helps you get the most out of the images that you scan on the machine. The software includes "Sharpdesk", a desktop document management application that enables integrated management of scanned images and files created using a variety of applications. To use the "Scan to Desktop" scanner function, the "Network Scanner Tool" must be installed from the CD-ROM. For the system requirements of the software, see the manual (PDF format) in the "Manual" folder or the Readme file on the CD-ROM. For the procedures for installing the software, see the "Information Guide".

## VERIFYING SYSTEM REQUIREMENTS

### SYSTEM REQUIREMENTS

Before installing the software described in this manual, make sure that your computer satisfies the following requirements.

	Windows*1	Macintosh*4
Operating system	Windows 2000 Professional, Windows XP Professional*2, Windows XP Home Edition, Windows 2000 Server, Windows Server 2003*2, Windows Vista*2, Windows Server 2008*2, Windows 7*2	Mac OS 9.0 to 9.2.2, Mac OS X v10.2.8, Mac OS X v10.3.9, Mac OS X v10.4.11, Mac OS X v10.5 to 10.5.8, Mac OS X v10.6 to 10.6.2
Computer type	IBM PC/AT compatible computer Equipped with a 10Base-T/100Base-TX/1000Base-T LAN board or equipped standard with a USB 2.0/1.1*3 port.	An environment in which any of the operating systems listed above can fully operate (including Macintosh computers with an Intel processor).
Display	1024 x 768 dots resolution and 16-bit color or higher is recommended.	
Other hardware requirements	An environment that allows any of the above operating systems to fully operate.	

\*1 The PCL5e printer driver will not run on any of the 64-bit editions of the Windows operating systems, Windows Server 2008 and Windows 7.

\*2 Includes the 64-bit edition.

\*3 Compatible with models preinstalled with Windows 2000 Professional, Windows XP Professional, Windows XP Home Edition, Windows 2000 Server, Windows Server 2003, Windows Vista, Windows Server 2008 or Windows 7, and which are equipped standard with a USB interface.

\*4 Cannot be used when the machine is connected with a USB cable. The PC-Fax driver and scanner driver cannot be used.



- **For users of Mac OS 9.0 to 9.2.2/X10.2.8/X10.3.9**

The CD-ROM does not include software for Mac OS 9.0 to 9.2.2/X10.2.8/X10.3.9.

Contact your dealer or nearest authorized service representative if you want software.

- **For users of Windows 2000/XP/Server 2003/Vista/Server 2008/7**

To perform the procedures described in this manual such as installing the software and configuring settings after installation, administrator authority is required.

## SOFTWARE REQUIREMENTS

The following requirements must be met to use the software described in this manual.

Operating system environment*1	Software	Required expansion kits	Type of connection*1
Windows	PCL6 printer driver, PCL5e printer driver	Can be used in the standard configuration.	Network/ USB
	PS printer driver, PPD driver		
	PC-Fax driver	Facsimile expansion kit*2	
	Scanner driver	Can be used in the standard configuration.	Network only*3 (cannot be used with a USB connection)
	Printer Status Monitor		
Macintosh	Macintosh PPD file		

\*1 For the types of computers and operating systems that can run the software, see "SYSTEM REQUIREMENTS" (page 26).

\*2 When the Internet fax expansion kit is installed, the PC-Fax driver can be updated using the "PRINTER UTILITIES" CD-ROM to enable the driver to be used as a PC-I-Fax driver. In this case, the driver can be used without the facsimile expansion kit.

\*3 The scanner driver and Printer Status Monitor cannot be used on an IPv6-only network.

## CONNECTING THE MACHINE

### CONNECTING TO A NETWORK

To connect the machine to a network, connect the LAN cable to the machine's network connector. Use a shielded LAN cable.

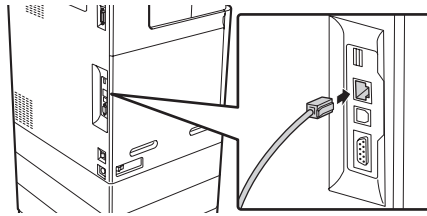

After connecting the machine to a network, be sure to configure the IP address and other network settings before installing the software. (The factory default setting for the IP address is to receive the IP address automatically when the machine is used in a DHCP environment.)

Network settings can be configured using "Network Settings" in the system settings (administrator) on the machine.



- If the machine is used in a DHCP environment, the IP address of the machine may change. If this happens, printing will not be possible. This problem can be avoided by using a WINS server or by assigning a permanent IP address to the machine.
- This manual explains how to set up the software in a Windows network environment.
- To use the machine on an IPv6 network, the IPv6 setting must be enabled in "Network Settings" in the system settings (administrator).

### ► Checking the IP address of the machine

You can check the IP address of the machine by printing out the "All Custom Setting List" in the system settings. Follow these steps to print out the "All Custom Setting List".

Press the [SYSTEM SETTINGS] key, touch the [List Print (User)] key, and then touch the [Print] key of "All Custom Setting List".

### CONNECTING THE MACHINE WITH A USB CABLE (Windows)

The machine can be connected to a computer using a USB cable if the computer is a Windows computer. (The USB interface on the machine cannot be used in a Macintosh environment.)

The machine and computer should be connected while the printer driver is being installed. If a USB cable is connected before the printer driver is installed, the printer driver will not be installed correctly. For the procedure for connecting a USB cable, see "WHEN THE MACHINE WILL BE CONNECTED WITH A USB CABLE" (page 1-90 in the Operation Guide).

---

---

# SETUP IN A WINDOWS ENVIRONMENT

This section explains how to install the software on a Windows computer. For more details regarding installation procedures and instructions for installation in Macintosh environments, see Chapter 1 of the Operation Guide.

## OPENING THE SOFTWARE SELECTION SCREEN (FOR ALL SOFTWARE)

---

### 1 Insert the "Software CD-ROM" into your computer's CD-ROM drive.

- If you are installing the printer driver or printer status monitor, insert the "Software CD-ROM" that shows "Disc 1" on the front of the CD-ROM.
- If you are installing the PC-Fax driver or scanner driver, insert the "Software CD-ROM" that shows "Disc 2" on the front of the CD-ROM.

---

### 2 Click the [Start] button () , click [Computer], and then double-click the [CD-ROM] icon ().

- In Windows XP/Server 2003, click the [start] button, click [My Computer], and then double-click the [CD-ROM] icon.
- In Windows 2000, double-click [My Computer] and then double-click the [CD-ROM] icon.

---

### 3 Double-click the [Setup] icon ().

In Windows 7, if a message screen appears asking you for confirmation, click [Yes].



In Windows Vista/Server 2008, if a message screen appears asking you for confirmation, click [Allow].

---

### 4 The "SOFTWARE LICENSE" window will appear. Make sure that you understand the contents of the license agreement and then click the [Yes] button.



You can show the "SOFTWARE LICENSE" in a different language by selecting the desired language from the language menu. To install the software in the selected language, continue the installation with that language selected.

**5** Read the message in the "Welcome" window and then click the [Next] button.

**6** The software selection screen appears.

Before installing the software, be sure to click the [Display Readme] button and view the detailed information on the software.

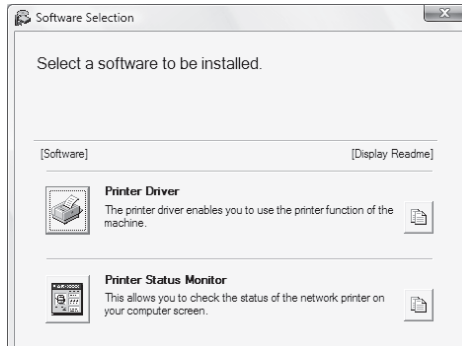

\* The above screen appears when using the "Disc 1" CD-ROM. For the steps that follow, see the appropriate page below for the software that you are installing.

**INSTALLING THE PRINTER DRIVER / PC-FAX DRIVER**

**• WHEN THE MACHINE IS CONNECTED TO A NETWORK\***

- Standard installation: page 32
- Installation by specifying the machine's address: page 1-85 in the Operation Guide
- Printing using the IPP function and the SSL function: page 1-88 in the Operation Guide

**• WHEN THE MACHINE WILL BE CONNECTED WITH A USB CABLE: page 1-90 in the Operation Guide**

**• USING THE MACHINE AS A SHARED PRINTER: page 1-95n the Operation Guide**

**INSTALLING THE PRINTER STATUS MONITOR: page 1-100 in the Operation Guide**

**INSTALLING THE SCANNER DRIVER: page 1-101 in the Operation Guide**

\* If the machine is being used on an IPv6 network, see "Installation by specifying the machine's address" (page 1-85 in the Operation Guide).



## INSTALLING THE PRINTER DRIVER / PC-FAX DRIVER

To install the printer driver or the PC-Fax driver, follow the appropriate procedure in this section depending on whether the machine is connected to a network or connected by USB cable.

 **WHEN THE MACHINE WILL BE CONNECTED WITH A USB CABLE** (page 1-90 in the Operation Guide)

### WHEN THE MACHINE IS CONNECTED TO A NETWORK

This section explains how to install the printer driver and the PC-Fax driver when the machine is connected to a Windows network (TCP/IP network).



- To print to the machine over the Internet using the IPP function when the machine is installed in a remote location, or to print using the SSL (encrypted communication) function, see "Printing using the IPP function and the SSL function" (page 1-88 in the Operation Guide) and install the printer driver or the PC-Fax driver.
- **If the machine is connected to an IPv6-only network**  
The software cannot be installed by detecting the machine's address from the installer. After installing the software as explained in "Installation by specifying the machine's address" (page 1-85 in the Operation Guide), change the port as explained in "Changing to a Standard TCP/IP Port" (page 1-105 in the Operation Guide).
- The installation procedure in this section is for both the printer driver and the PC-Fax driver, although the explanations are centered on the printer driver.

## ► Standard installation

When the software selection screen appears in step 6 of "OPENING THE SOFTWARE SELECTION SCREEN (FOR ALL SOFTWARE)" (page 29), perform the steps below.

### 1 Click the [Printer Driver] button.

To install the PC-Fax driver, click the [PC-Fax Driver] button on the "Disc 2" CD-ROM.

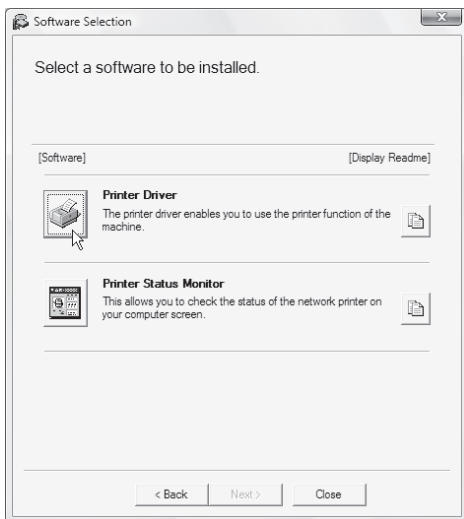

\* The above screen appears when using the "Disc 1" CD-ROM.

### 2 Click the [Standard installation] button.

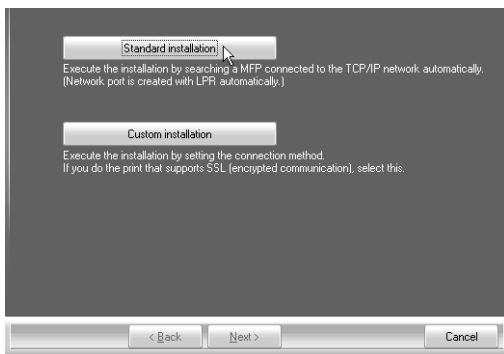



When [Custom installation] is selected, you can change any of the items below. When [Standard installation] is selected, the installation will take place as indicated below.

- Machine connection method: LPR Direct Print (Auto Search)
- Set as default printer: Yes (excluding the PC-Fax driver)
- Printer driver name: Cannot be changed
- PCL printer display fonts: Installed

If you selected [Custom installation], select [LPR Direct Print (Auto Search)] and click the [Next] button.

If you selected other than [LPR Direct Print (Auto Search)], see the following pages in the Operation Guide:

- LPR Direct Print (Specify Address): page 1-85
- IPP: page 1-88
- Shared printer: page 1-95
- Connected to this computer: page 1-90

### 3

**Printers connected to the network are detected. Select the machine and click the [Next] button.**

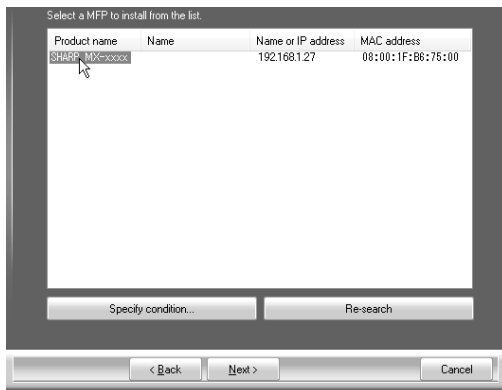

- If the machine is not found, make sure that the machine is powered on and that the machine is connected to the network, and then click the [Re-search] button.
- You can also click the [Specify condition] button and search for the machine by entering the machine's name (host name) or IP address.
  - ☞ Checking the IP address of the machine (page 28)

**4** A confirmation window appears. Check the contents and then click the [Next] button.

**5** When the printer driver selection window appears, select the printer driver to be installed and click the [Next] button.

Click the checkbox of the printer driver to be installed so that a checkmark () appears.

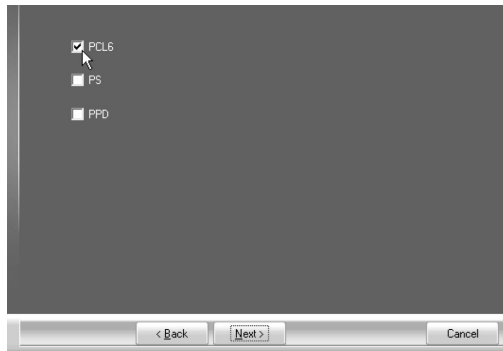

When the PC-Fax driver is being installed, this screen does not appear. Go to the next step.

**6** When you are asked whether or not you want the printer to be your default printer, make a selection and click the [Next] button.

If you are installing multiple drivers, select the printer driver to be used as the default printer.

If you do not wish to set one of the printer drivers as the default printer, select [No].



If you clicked the [Custom installation] button in step 2, the following windows will appear.

- **Printer name window**

If you wish to change the printer name, enter the desired name and click the [Next] button.

- **Window confirming installation of the display fonts**

To install the display fonts select [Yes] and click the [Next] button.

- When the PC-Fax driver is being installed, this screen does not appear. Go to the next step.
- If you are not installing the PCL printer driver (you are installing the PS printer driver or the PPD driver), select [No] and click the [Next] button.

## 7

### Follow the on-screen instructions.

Read the message in the window that appears and click the [Next] button. Installation begins.



- **If you are using Windows Vista/Server 2008/7**

If a security warning window appears, be sure to click [Install this driver software anyway].

- **If you are using Windows 2000/XP/Server 2003**

If a warning message regarding the Windows logo test or digital signature appears, be sure to click the [Continue Anyway] or [Yes] button.

## 8

### When the installation completed screen appears, click the [OK] button.

## 9

### Click the [Close] button in the window of step 1.



After the installation, a message prompting you to restart your computer may appear. If this message appears, click the [Yes] button to restart your computer.

### **This completes the installation.**

- After installation, see "CONFIGURING THE PRINTER DRIVER FOR THE OPTIONS INSTALLED ON THE MACHINE" (page 1-97 in the Operation Guide) to configure the printer driver settings.
- If you are using the machine as a shared printer, see "USING THE MACHINE AS A SHARED PRINTER" (page 1-95 in the Operation Guide) to install the printer driver on each of the client computers.

---

---

# REGULAR MAINTENANCE

To ensure that the machine continues to provide top quality performance, periodically clean the machine.

## Warning

**Do not use a flammable spray to clean the machine. If gas from the spray comes in contact with hot electrical components or the fusing unit inside the machine, fire or electrical shock may result.**



- Do not use thinner, benzene, or similar volatile cleaning agents to clean the machine. These may degrade or discolor the housing.
- Use a soft cloth to gently wipe off dirt from the area on the operation panel with a mirror-like finish (shown at right). If you use a stiff cloth or rub hard, the surface may be damaged.

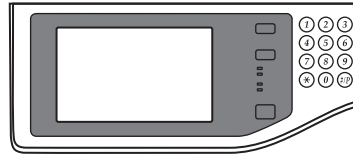

The area with a mirror-like finish is the area that is .

---

## Cleaning the document glass and automatic document feeder

If the document glass or document backplate sheet becomes dirty, the dirt will appear as dirty spots, or black or white lines in the scanned image. Always keep these parts clean. Wipe the parts with a clean, soft cloth.

If necessary, moisten the cloth with water or a small amount of neutral detergent. After wiping with the moistened cloth, wipe the parts dry with a clean dry cloth.

### Document glass

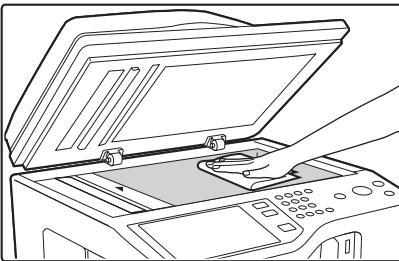

### Document backplate sheet

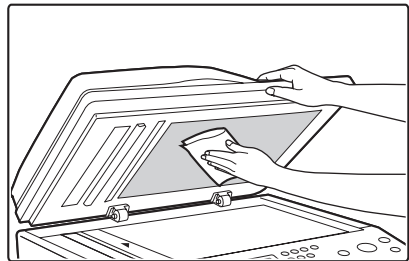

When wiping dirt off the machine, do not press down hard on the machine. This may damage or deform the machine.

---

---

# SUPPLIES

Standard supplies for this product that can be replaced by the user include paper, toner cartridges, and staple cartridges for the finisher.

Be sure to use only SHARP-specified products for the toner cartridges, finisher staple cartridge, and transparency film.

**SHARP**

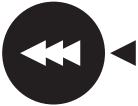

**GENUINE SUPPLIES**

For best copying results, be sure to use only Sharp Genuine Supplies which are designed, engineered, and tested to maximize the life and performance of Sharp products. Look for the Genuine Supplies label on the toner package.

## Storage of supplies

### Proper storage

1. Store the supplies in a location that is:
  - clean and dry
  - at normal temperature with minimal temperature fluctuations
  - not exposed to direct sunlight
2. Store paper in the wrapper and lying flat.
3. Paper stored in packages standing up or out of the wrapper may curl or become damp, resulting in paper misfeeds.

### Storing toner cartridges

Store the box that contains the toner cartridge horizontally; do not store it standing up. If the toner cartridge is stored standing up, the toner may solidify inside the cartridge.

Store the toner in a location that is cooler than 104°F (40°C). Storage in a hot location may cause the toner in the cartridge to solidify.

### Staple cartridge

The finisher requires the following staple cartridge:

MX-SCX1 (for finisher)

Approx. 5000 per cartridge x 3 cartridges

### Supply of spare parts and consumables

The supply of spare parts for repair of the machine is guaranteed for at least 7 years following the termination of production. Spare parts are those parts of the machine which may break down within the scope of the ordinary use of the product, whereas those parts which normally exceed the life of the product are not to be considered as spare parts. Consumables too, are available for 7 years following the termination of production.



# SPECIFICATIONS

## Machine specifications / copier specifications

<b>Name</b>	Digital Multifunctional System MX-B402/MX-B402SC	
<b>Type</b>	Desktop	
<b>Display</b>	7 inch color touch panel LCD	
<b>Photoconductive type</b>	OPC drum	
<b>Printing method</b>	Electrophotographic system (laser)	
<b>Developer system</b>	Dry-type two-component magnetic brush development	
<b>Fusing system</b>	Heat rollers	
<b>Scanning resolution</b>	Document glass	Black and white scanning: 600 x 300 dpi 600 x 600 dpi (factory default values) Color scanning: 600 x 300 dpi 600 x 600 dpi (factory default values)
	Automatic document feeder	Black and white scanning: 600 x 300 dpi (factory default values) 600 x 600 dpi Color scanning: 600 x 300 dpi (factory default values) 600 x 600 dpi
<b>Copying resolution</b>	600 x 600 dpi	
<b>Scanning gradation</b>	10 bits	
<b>Printing gradation</b>	Equivalent to 256 levels	
<b>Original sizes / types (Document Glass)</b>	Max. 8-1/2" x 11" (A4) / sheets, bound documents	
<b>Copy sizes</b>	Maximum: 8-1/2" x 11" (A4) Minimum: 5-1/4" x 5-3/4" (A5)	
<b>Print margins</b>	Leading edge / trailing edge: total 21/64" (8 mm) or less, near edge / far edge: total 21/64" (8 mm) or less	

## Machine specifications / copier specifications (Continued)

<b>Warm-up time</b>	90 seconds or less (This may vary depending on the ambient conditions.)
<b>First-copy time</b>	8.0 seconds or less (This may vary depending on the state of the machine.)
<b>Copy ratios</b>	Variable: 50% to 200% in increments of 1%, total 151 increments Fixed presets: 50%, 64%, 77%, 100%, 129% and 200% for inch sizes; 50%, 70%, 81%, 86%, 100%, 115%, 122%, 141% and 200% for AB sizes. Two reduction ratios and two enlargement ratios can be stored.
<b>Continuous copy</b>	999 copies
<b>Automatic document feeder</b>	See "Automatic document feeder specifications".
<b>Tray 1</b>	Paper sizes: 8-1/2" x 14", 8-1/2" x 13-1/2", 8-1/2" x 13-2/5", 8-1/2" x 13", 8-1/2" x 11", 7-1/4" x 10-1/2", 5-1/2" x 8-1/2", A4, B5, A5, 16K Paper weight: Plain paper (16 lbs. to 28 lbs. (60 g/m <sup>2</sup> to 105 g/m <sup>2</sup> )) Paper capacity: Plain paper (21 lbs. (80 g/m <sup>2</sup> )) 500 sheets Paper types: SHARP-recommended plain paper, recycled paper and colored paper

## Machine specifications / copier specifications (Continued)

<b>Bypass tray</b>	Paper sizes: 8-1/2" x 14", 8-1/2" x 13-1/2", 8-1/2" x 13-2/5", 8-1/2" x 13", 8-1/2" x 11", 7-1/4" x 10-1/2", 5-1/2" x 8-1/2", envelopes, A4, B5, A5, 16K
	Paper weights: Thin paper (15 lbs. to 16 lbs. (55 g/m <sup>2</sup> to 59 g/m <sup>2</sup> )), plain paper (16 lbs. to 28 lbs. (60 g/m <sup>2</sup> to 105 g/m <sup>2</sup> )), heavy paper (28 lbs. bond to 110 lbs. index (106 g/m <sup>2</sup> to 209 g/m <sup>2</sup> ))
	Paper capacity: Standard paper 100 sheets
	Paper types: SHARP-recommended plain paper, recycled paper, colored paper, heavy paper, thin paper, transparency film, and envelopes (Monarch, Com-10, DL, C5)
<b>Duplex module</b>	Paper sizes: 8-1/2" x 14", 8-1/2" x 13-1/2", 8-1/2" x 13-2/5", 8-1/2" x 13", 8-1/2" x 11", 5-1/2" x 8-1/2", A4, B5, A5, 16K Paper weight: Plain paper (16 lbs. to 28 lbs. (60 g/m <sup>2</sup> to 105 g/m <sup>2</sup> )) Paper types: SHARP-recommended plain paper, recycled paper, and colored paper
<b>Output tray (Center tray)</b>	Output method: Face-down output Output capacity: 250 sheets (using SHARP-recommended 8-1/2" x 11" or A4 paper) (The maximum number of sheets that can be held varies depending on ambient conditions in the installation location, the type of paper, and the storage conditions of the paper.) Tray full sensor: Yes
<b>Interface port</b>	LAN connectivity: 10Base-T / 100Base-TX / 1000Base-T USB connectivity: Type A connector supports USB 2.0 (Hi speed)* Compatibility requirements of USB 2.0 Disk Format: FAT Type B connector supports USB 2.0 (Hi speed)

## Machine specifications / copier specifications (Continued)

<b>Required power supply</b>	AC 120 V $\pm$ 10% 60 Hz
<b>Power consumption</b>	1.44 kW
<b>Dimensions</b>	MX-B402: 22-3/64" (W) x 19-13/32" (D) x 28-7/64" (H) (560 mm (W) x 493 mm (D) x 714 mm (H)) MX-B402SC: 22-3/64" (W) x 19-29/64" (D) x 31-1/16" (H) (560 mm (W) x 494 mm (D) x 789 mm (H))
<b>Weight</b>	MX-B402: Approx. 92.6 lbs. (42 kg) MX-B402SC: Approx. 103.6 lbs. (47 kg)
<b>Overall dimensions</b>	MX-B402: 34-11/64" (W) x 19-13/32" (D) (868 mm (W) x 493 mm (D)) (when bypass tray is extended) MX-B402SC: 43-11/32" (W) x 19-29/64" (D) (1101 mm (W) x 494 mm (D)) (when bypass tray is extended)

\* Type A connectors are located on the front and back right of the machine (two connectors); however, the connectors cannot be used simultaneously on the MX-B402. The connector on the back of the machine is not initially available for use. If you wish to use the connector, contact your service assistance.

## Continuous copying speeds\*

<b>Copy ratio</b>	100% / Reduced / Enlarged
<b>8-1/2" x 14", 8-1/2" x 13-1/2", 8-1/2" x 13-2/5", 8-1/2" x 13"</b>	32 copies/min.
<b>A4</b>	38 copies/min.
<b>8-1/2" x 11", 7-1/4" x 10-1/2", 5-1/2" x 8-1/2", B5, A5, 16K</b>	40 copies/min.

\* Copy speed during output of the second copy and following copies when performing continuous one-sided copying of the same page (excluding offset output) using plain one-sided paper from a tray other than the bypass tray.

## Ambient environment

<b>Temperature</b>	54°F to 86°F (10°C to 35°C)
<b>Humidity</b>	20% to 85%

## Chemical emission (measured according to RAL-UZ122: Edition Jun. 2006)

<b>Ozone</b>	1.5 mg/h or less
<b>Dust</b>	4.0 mg/h or less
<b>Styrene</b>	-
<b>Benzene</b>	-
<b>TVOC</b>	10 mg/h or less

## Acoustic noise emission (measurement according to ISO7779)

Sound power level L <sub>WA</sub>		
<b>Printing mode (continuous printing)</b>		MX-B402: 6.8 B MX-B402SC: 6.8 B
<b>Standby mode</b>		MX-B402: 4.9 B MX-B402SC: 4.8 B
Sound pressure level L <sub>pA</sub> (actual measurement)		
<b>Printing mode</b>	<b>Bystander positions</b>	MX-B402: 54 dB (A) MX-B402SC: 53 dB (A)
	<b>Operator positions</b>	MX-B402: 56 dB (A) MX-B402SC: 54 dB (A)
<b>Standby mode</b>	<b>Bystander positions</b>	MX-B402: 36 dB (A) MX-B402SC: 36 dB (A)
	<b>Operator positions</b>	MX-B402: 36 dB (A) MX-B402SC: 34 dB (A)

## Automatic document feeder specifications

<p><b>Original sizes</b></p>	<p>MX-B402: 8-1/2" x 14" to 5-1/2" x 8-1/2", A4 to A5, long paper (max. width 8-1/2" (216 mm) x max. length 19-5/8"*1 (500 mm)) MX-B402SC: 8-1/2" x 14" to 5-1/2" x 8-1/2", A4 to A5, long paper (max. width 8-1/2" (216 mm) x max. length 19-5/8"*1 (500 mm))</p>
<p><b>Original weight*2</b></p>	<p>MX-B402: One-sided 9 lbs. to 32 lbs. (35 g/m<sup>2</sup> to 128 g/m<sup>2</sup>) (Paper weights from 9 lbs. (35 g/m<sup>2</sup>) to 13 lbs. (49 g/m<sup>2</sup>) require the use of slow scan mode.) Two-sided 13 lbs. to 28 lbs. (50 g/m<sup>2</sup> to 105 g/m<sup>2</sup>) MX-B402SC: One-sided 9 lbs. to 73 lbs. (35 g/m<sup>2</sup> to 280 g/m<sup>2</sup>) (Paper weights from 9 lbs. (35 g/m<sup>2</sup>) to 13 lbs. (49 g/m<sup>2</sup>) require the use of slow scan mode.) Two-sided 13 lbs. to 73 lbs. (50 g/m<sup>2</sup> to 280 g/m<sup>2</sup>)</p>
<p><b>Capacity</b></p>	<p>MX-B402: 50 sheets (21 lbs. (80 g/m<sup>2</sup>)) Maximum stack height of 1/4" (6.5 mm) MX-B402SC: 100 sheets (21 lbs. (80 g/m<sup>2</sup>)) Maximum stack height of 1/2" (13 mm)</p>

\*1 Scanning in mono 2 mode of one side only is possible in fax and scan send modes.

\*2 Heavy paper (34 lbs. to 75 lbs. (129 g/m<sup>2</sup> to 280 g/m<sup>2</sup>)) is only discharged at the heavy exit.

Contact at:

Information that the administrator of the machine requires is printed on the back of this page.

(Separate this page from the manual and keep it in a safe place. In addition, fill in the name of the administrator and the administrator's contact information in the left hand margin.)



Name:

Administrator

---

---

# TO THE ADMINISTRATOR OF THE MACHINE

(Separate this page from the manual and keep it in a safe place.)

## Factory default passwords

When accessing the system settings, the administrator password is required to log in with administrator rights. The system settings can be configured in the Web pages as well as on the operation panel. To access the system settings using the Web pages, a password is also required.

### Factory default administrator password

**Factory default setting: admin**

Store a new administrator password as soon as the machine is installed. Once the administrator password has been changed, the new password is required to restore the factory default password. Take care to remember the new password.

### Factory default passwords (Web pages)

There are two factory default accounts: "Administrator" and "User". A person who logs in as an "Administrator" can configure all settings in the Web pages. In addition, an administrator can restrict access to other settings by enabling "User" accounts. The factory default passwords are shown below.

	Factory default account	Factory default password
User	users	users
Administrator	admin	admin



## Forwarding all transmitted and received data to the administrator (document administration function)

This function is used to forward all data transmitted and received by the machine to a specified destination (Scan to E-mail address, Scan to FTP destination, Scan to Network Folder destination, or Scan to Desktop destination).

This function can be used by the administrator of the machine to archive all transmitted and received data.

To configure the document administration settings, click [Application Settings] and then [Document Administration Function] in the Web page menu. (Administrator rights are required.)

### Note:

- The format, exposure, and resolution settings of transmitted and received data remain in effect when the data is forwarded.
- When forwarding is enabled for data sent in fax mode,
  - The [Direct TX] key does not appear in the touch panel.
  - Quick online transmission and dialing using the speaker cannot be used.



## For the users of the fax function

### ABOUT THE TELEPHONE CONSUMER PROTECTION ACT OF 1991

The Telephone Consumer Protection Act of 1991 makes it unlawful for any person to use a computer or other electronic device, including FAX machines, to send any message unless such message clearly contains in a margin at the top or bottom of each transmitted page or on the first page of the transmission, the date and time it is sent and an identification of the business or other entity, or other individual sending the message and the telephone number of the sending machine or such business, other entity, or individual.

(The telephone number provided may not be a 900 number or any other number for which charges exceed local or long-distance transmission charges.)

In order to program this information into your FAX machine, you should complete the following steps:

See "Own Name and Destination Set" on page 7-81 of Operation Guide.

### Important safety instructions

- If any of your telephone equipment is not operating properly, you should immediately remove it from your telephone line, as it may cause harm to the telephone network.
- The AC power outlet shall be installed near the equipment and shall be easily accessible.
- Never install telephone wiring during a lightning storm.
- Never install telephone jacks in wet locations unless the jack is specifically designed for wet locations.
- Never touch uninsulated telephone wires or terminals unless the telephone line has been disconnected at the network interface.
- Use caution when installing or modifying telephone lines.
- Avoid using a telephone (other than a cordless type) during an electrical storm. There may be a remote risk of electric shock from lightning.
- Do not use a telephone to report a gas leak in the vicinity of the leak.
- Do not install or use the machine near water, or when you are wet. Take care not to spill any liquids on the machine.
- Save these instructions.

**FCC Notice to users:**

This equipment complies with Part 68 of the FCC rules and the requirements adopted by the ACTA.

On this equipment is a label that contains, among other information, a product identifier in the format US:AAAEQ##TXXXX.

If requested, this number must be provided to the telephone company.

The REN is used to determine the number of devices that may be connected to a telephone line.

Excessive RENs on a telephone line may result in the devices not ringing in response to an incoming call.

In most but not all areas, the sum of RENs should not exceed five (5.0).

To be certain of the number of devices that may be connected to a line, as determined by the total RENs, contact the local telephone company.

For products approved after July 23, 2001, the REN for this product is part of the product identifier that has the format US: AA AEQ##TXXXX.

The digits represented by ## are the REN without a decimal point (e.g., 03 is a REN of 0.3). For earlier products, the REN is separately shown on the label.

If this equipment causes harm to the telephone network, your telephone company may disconnect your service temporarily. If possible, they will notify you in advance. If advance notice is not practical, you will be notified as soon as possible. You will also be advised of your right to file a complaint with the FCC.

Your telephone company may make changes in its facilities, equipment, operations, or procedures that could affect the operation of your equipment. If this happens, the telephone company will provide advance notice in order for you to make necessary modifications to maintain uninterrupted service. If the equipment is causing harm to the telephone network, your telephone company may ask you to disconnect the equipment until the problem is resolved.

If you have any questions or problems which cannot be solved by reading this manual, please contact.

<p><b>Sharp Electronics Corporation</b> 1 Sharp Plaza Mahwah, NJ 07495 Telephone: 1-800-BE-SHARP</p>
------------------------------------------------------------------------------------------------------------------

A plug and jack used to connect this equipment to the premises wiring and telephone network must comply with the applicable FCC Part 68 rules and requirements adopted by the ACTA.

A compliant telephone cord and modular plug is provided with this product.

It is designed to be connected to a compatible modular jack that is also compliant. See installation instructions for details.

This equipment connects to the telephone network through a standard USOC RJ-11C network interface jack.

If your home has specially wired alarm equipment connected to the telephone line, ensure the installation of this equipment does not disable your alarm equipment.

If you have questions about what will disable alarm equipment, consult your telephone company or a qualified installer.

This equipment may not be used on coin service provided by the telephone company. Connection to party lines service is subject to state tariffs.

Contact your state's public utility commission, public service commission or corporation commission for more information.

## **NOTICE for users in the USA**

**BE SURE TO ASK YOUR AUTHORIZED SHARP DEALER ABOUT THE WARRANTY THAT YOUR SELLING DEALER EXTENDS TO YOU.** In order to assure you, the end-user, of warranty protection, Sharp extends a limited warranty to each of its authorized dealers and, in turn, requires each of its authorized dealers to extend its own warranty to you on terms that are no less favorable than those given to the dealer by Sharp. You should be aware, however, that Sharp does not itself extend any warranties, either express or implied, directly to you, the end-user, and no one is authorized to make any representations or warranties on behalf of Sharp. Specifically, SHARP DOES NOT EXTEND TO YOU, THE END-USER, ANY EXPRESS WARRANTY OR ANY IMPLIED WARRANTY OF MERCHANTABILITY, FITNESS FOR USE OR FITNESS FOR ANY PARTICULAR PURPOSE IN CONNECTION WITH THE HARDWARE, SOFTWARE OR FIRMWARE EMBODIED IN, OR USED IN CONJUNCTION WITH THIS PRODUCT. Sharp is not responsible for any damages or loss, either direct, incidental or consequential, which you, the end-user, may experience as a result of your purchase or use of the hardware, software or firmware embodied in or used in conjunction with this Product. Your sole remedy, in the event that you encounter any difficulties with this Product, is against the authorized dealer from which you purchased the Product.

**MX-B402 Digital Multifunctional System  
MX-B402SC Digital Multifunctional System**

In the event that this authorized dealer does not honor its warranty commitments, please contact the General Manager, Business Products Group, Sharp Electronics Corporation, 1 Sharp Plaza, Mahwah, NJ 07495-1163, so that Sharp can try to help assure complete satisfaction of all the warranty rights to which you are entitled from the authorized dealer.

## NOTICE FOR USERS IN CANADA

**"NOTICE :** This product meets the applicable Industry Canada technical specifications."

**"NOTICE :** The Ringer Equivalence Number is an indication of the maximum number of devices allowed to be connected to a telephone interface. The termination on an interface may consist of any combination of devices subject only to the requirement that the sum of the RENs of all the devices does not exceed five."

The REN of this equipment is indicated on the facsimile expansion kit.

## AVIS POUR NOS UTILISATEURS AU CANADA

**AVIS :** Le présent matériel est conforme aux spécifications techniques applicables d'Industrie Canada.

**Remarque :** L'indice d'équivalence de la sonnerie (IES) sert à indiquer le nombre maximal de terminaux qui peuvent être raccordés à une interface téléphonique. La terminaison d'une interface peut consister en une combinaison quelconque de dispositifs, à la seule condition que la somme d'indices d'équivalence de la sonnerie de tous les dispositifs n'excède pas 5.

L'indice d'équivalence de la sonnerie (IES) de cet équipement est indiqué sur le kit d'extension télécopieur.

**Sharp Electronics of Canada Ltd.**  
335 Britannia Road East  
Mississauga, Ontario, L4Z 1W9  
Canada

## Trademark acknowledgments

The following trademarks and registered trademarks are used in conjunction with the machine and its peripheral devices and accessories.

- Microsoft®, Windows®, Windows® 98, Windows® Me, Windows NT® 4.0, Windows® 2000, Windows® XP, Windows Server® 2003, Windows Vista®, Windows Server® 2008, Windows® 7 and Internet Explorer® are registered trademarks or trademarks of Microsoft Corporation in the U.S.A. and other countries.
- PostScript is a registered trademark of Adobe Systems Incorporated.
- Adobe and Flash are registered trademarks or trademarks of Adobe Systems Incorporated in the United States and other countries.
- Adobe, the Adobe logo, Acrobat, the Adobe PDF logo, and Reader are registered trademarks or trademarks of Adobe Systems Incorporated in the United States and other countries.
- Macintosh, Mac OS, AppleTalk, EtherTalk and LaserWriter are trademarks of Apple Inc., registered in the U.S. and other countries.
- Netscape Navigator is a trademark of Netscape Communications Corporation.
- Mozilla® and Firefox® are registered trademarks or trademarks of the Mozilla Foundation in the U.S.A. and other countries.
- PCL is a registered trademark of the Hewlett-Packard Company.
- IBM, PC/AT, and PowerPC are trademarks of International Business Machines Corporation.
- Sharpdesk is a trademark of Sharp Corporation.
- Sharp OSA is a trademark of Sharp Corporation.
- RealVNC is a trademark of RealVNC Limited.
- All other trademarks and copyrights are the property of their respective owners.

Candid and Taffy are trademarks of Monotype Imaging, Inc. registered in the United States Patent and Trademark Office and may be registered in certain jurisdictions. CG Omega, CG Times, Garamond Antiqua, Garamond Halbfett, Garamond Kursiv, Garamond and Halbfett Kursiv are trademarks of Monotype Imaging, Inc. and may be registered in certain jurisdictions. Albertus, Arial, Coronet, Gill Sans, Joanna and Times New Roman are trademarks of The Monotype Corporation registered in the United States Patent and Trademark Office and may be registered in certain jurisdictions. Avant Garde, ITC Bookman, Lubalin Graph, Mona Lisa, Zapf Chancery and Zapf Dingbats are trademarks of International Typeface Corporation registered in the United States Patent and Trademark Office and may be registered in certain jurisdictions. Clarendon, Eurostile, Helvetica, Optima, Palatino, Stempel Garamond, Times and Univers are trademarks of Heidelberger Druckmaschinen AG, which may be registered in certain jurisdictions, exclusively licensed through Linotype Library GmbH, a wholly owned subsidiary of Heidelberger Druckmaschinen AG. Apple Chancery, Chicago, Geneva, Monaco and New York are trademarks of Apple Computer Inc. and may be registered in certain jurisdictions. HGGothicB, HGMMinchoL, HGP GothicB and HGPMInchoL are trademarks of Ricoh Company, Ltd. and may be registered in some jurisdictions. Wingdings is a registered trademark of Microsoft Corporation in the United States and other countries. Marigold and Oxford are trademarks of Arthur Baker and may be registered in some jurisdictions. Antique Olive is a trademark of Marcel Olive and may be registered in certain jurisdictions. Hoefler Text is a trademark of Johnathan Hoefler and may be registered in some jurisdictions. ITC is a trademark of International Typeface Corporation registered in the United States Patent and Trademark Office and may be registered in certain jurisdictions. Agfa is a trademark of the Agfa-Gevaert Group and may be registered in certain jurisdictions. Intellifont, MicroType and UFST are trademarks of Monotype Imaging, Inc. registered in the United States Patent and Trademark Office and may be registered in certain jurisdictions. Macintosh and TrueType are trademarks of Apple Computer Inc. registered in the United States Patent and Trademark Office and other countries. PostScript is a trademark of Adobe Systems Incorporated and may be registered in some jurisdictions. HP, PCL, FontSmart and LaserJet are trademarks of Hewlett-Packard Company and may be registered in some jurisdictions. The Type 1 processor resident in Monotype Imaging's UFST product is under license from Electronics For Imaging, Inc. All other trademarks are the property of their respective owners.





# SHARP®

**SHARP ELECTRONICS CORPORATION**  
1 Sharp Plaza, Mahwah, New Jersey 07495-1163.

[www.sharppusa.com](http://www.sharppusa.com)

**SHARP ELECTRONICS OF CANADA LTD.**  
335 Britannia Road East, Mississauga, Ontario, L4Z 1W9

SHARP CORPORATION



This manual has been printed using a vegetable-based soy oil ink to help protect the environment.

**PRINTED IN CHINA**  
2010F KS1  
TINSE4753FCZZ